

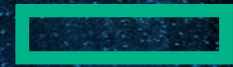

10/18/2019



Hewlett Packard
Enterprise

CAEML Research in Hardware Design and Optimization Using Machine Learning

Chris Cheng, Distinguished Technologist
Yongjin Choi, Master Technologist
Sumon Dey, Specialist Machine Learning Engineer

Content

- Introduction to CAEML
- Unique types of machine learning models for IoT and hardware system management
- Example small learning : proactive hardware failure prediction
- Example medium learning : 56G PAM SerDes performance optimization
- Example deep learning : Dynamic resources demand forecast



Vision

The center's goal is to **enable fast, accurate design and verification of microelectronic circuits and systems by creating machine learning algorithms to derive models used for electronic design automation.**

By speeding up the design and verification of microelectronic circuits and systems, CAEML will reduce development cost and time-to-market for manufacturers of microelectronic products, and will enable the development of optimized products, e.g. for low-power, high-reliability or security.

CAEML Members 2019



IoT management model

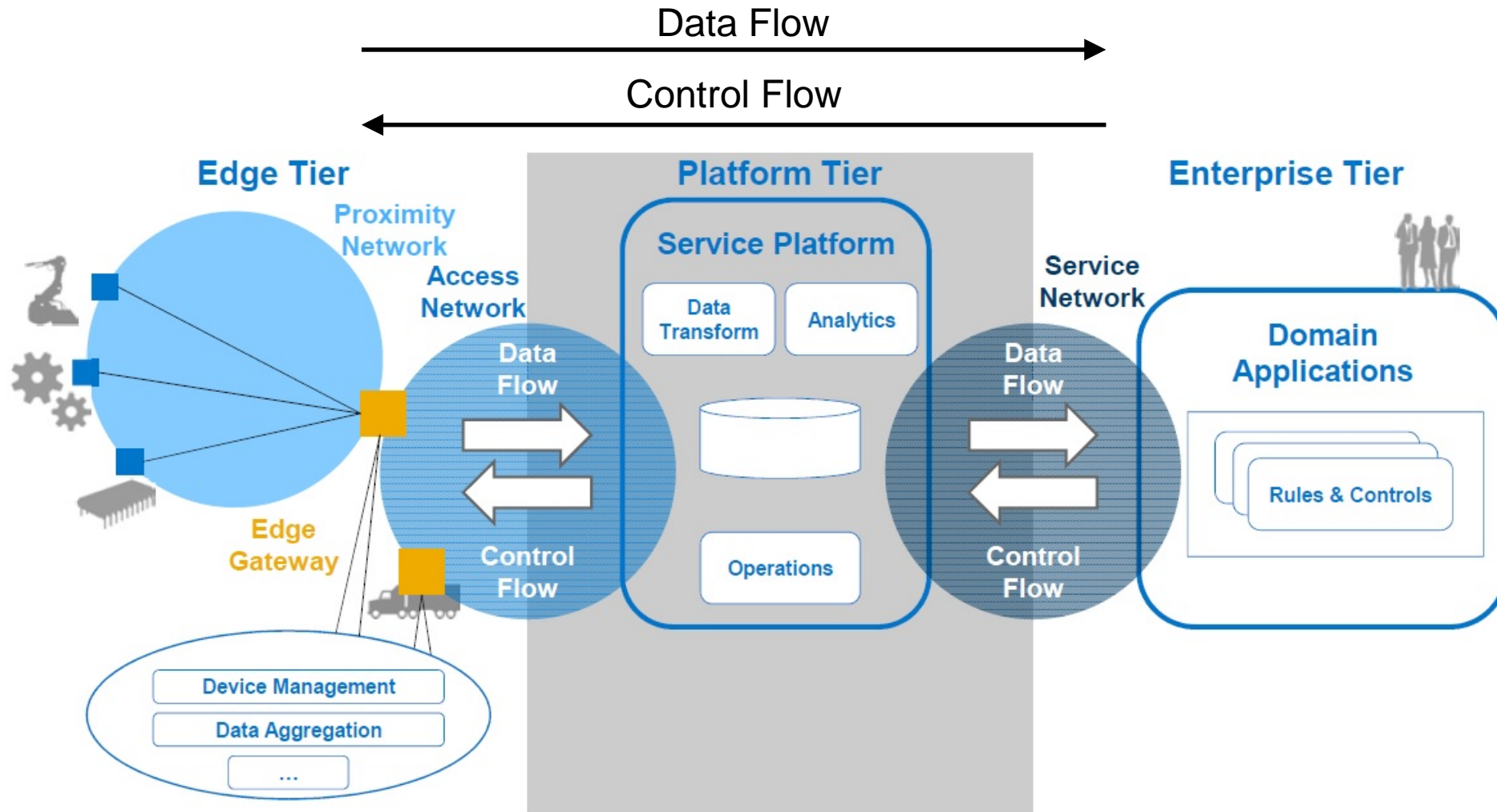

IEC IoT white paper

Edge inference

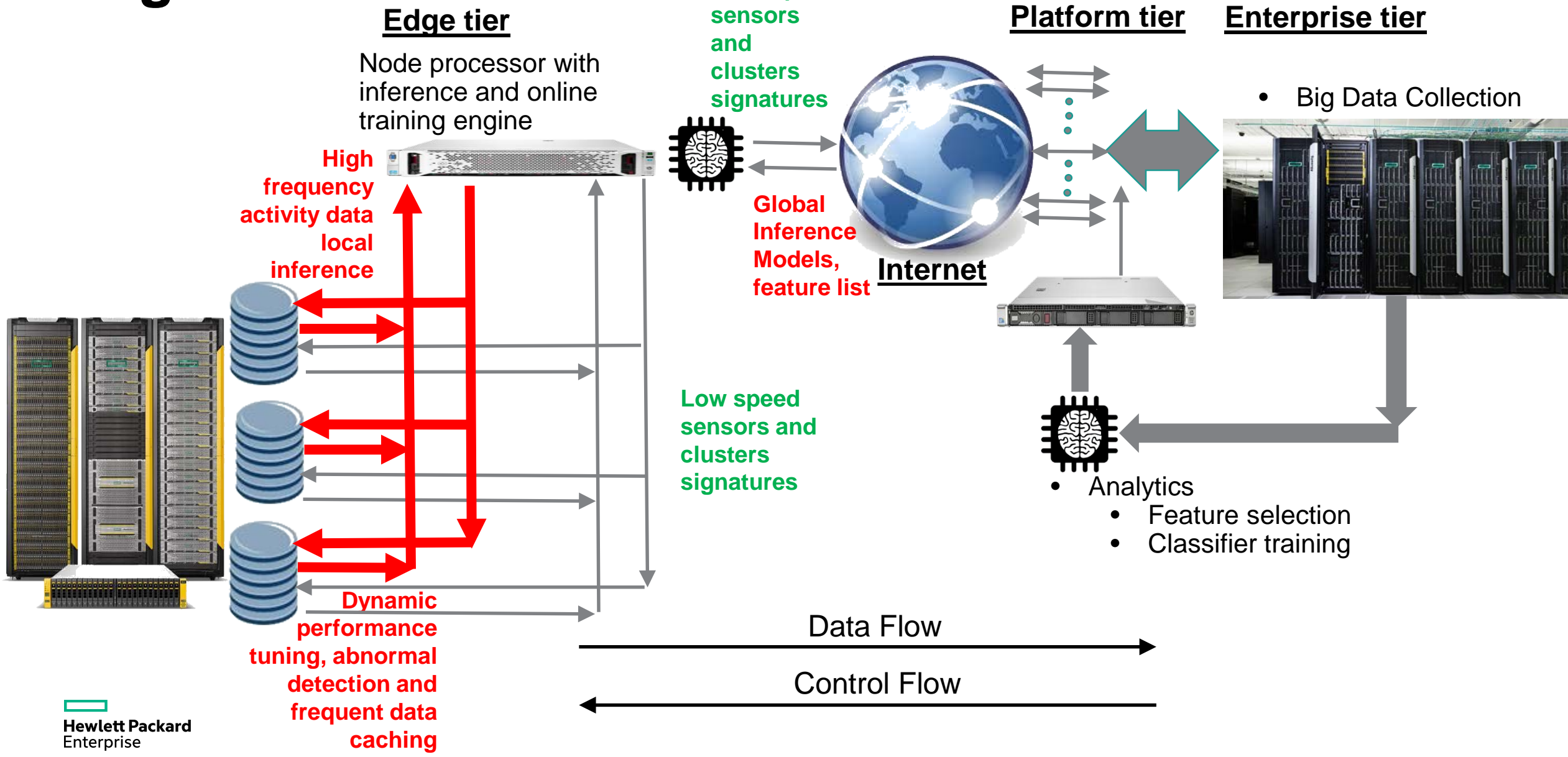

3 Types of IOT and hardware management models



	Feature size (number of variables or complexity)	Prediction throughput	Prediction interval	Machine learning engine	Examples
Big data Small learning	Less than 100	A few thousands to millions of predictions per sec	Variable from days to ms	Ensemble classifier	Hardware failure prediction Software failure prediction Automatic application detection Storage security applications (ransomware detection) System abnormally detection
Big data Medium learning	Between 100 to 500	A few hundred predictions per secs	A few secs	Generative surrogate model with Bayesian learning	Dynamic system performance optimization
Big data Deep learning	100s to 1000s	1000's of predictions in an hours	5-15 mins	Deep Markovian Models Deep learning neural networks	High dimensional time series for resource demand prediction

Small learning example : proactive hardware failure detection

Proactive hardware failure prediction



➤ Window N = 5 :

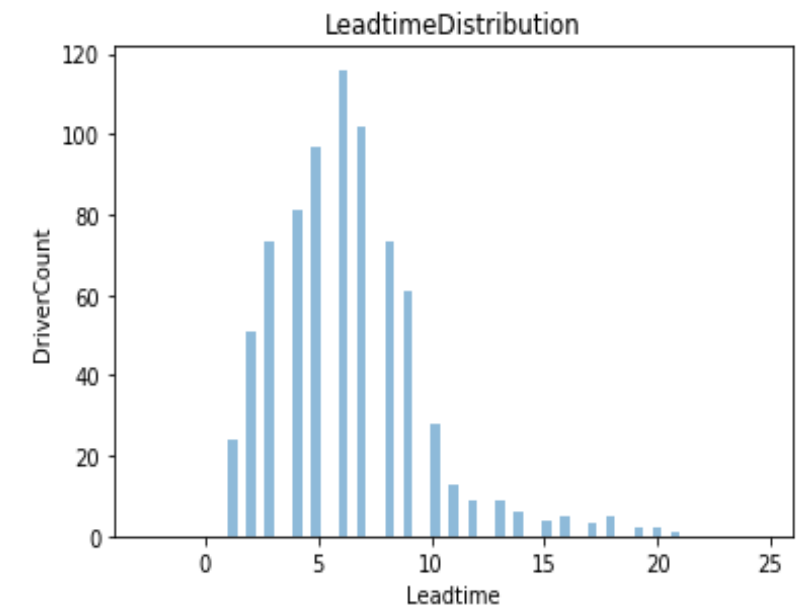

Average Lead Time = 6.28 days

Recommended MATLAB package : Statistics and Machine Learning Tool Box

Causal inference for feature selection

Predict Y_{T_n} from $(X_k)_{T_n-t_{adv}-w_k}^{T_n-t_{adv}}$ for each feature X_k

- Causal inference is used to pick the sensor signals and sample window
- 30% features reduction
- 15% accuracy improvement

Prediction Windows

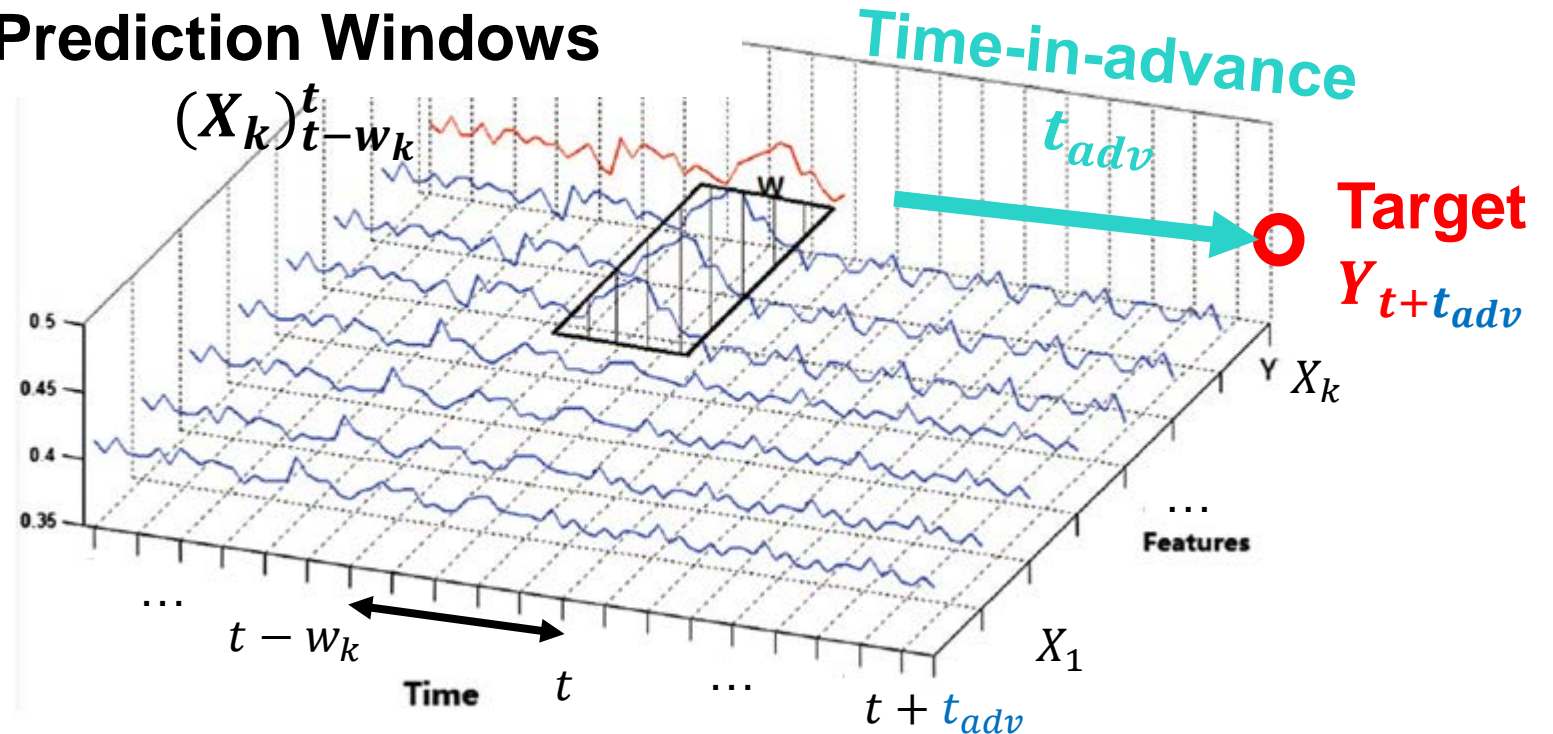

CAEMML research

Performance limitation of GPU on ensemble classifier

Relative inference time

Number of samples	Intel CPU	CUDA-Tree
10k	1	2.2
20k	1	2
50k	1	1.8

Higher is slower execution time
GPU is slower than Intel CPU !

Control Flow Problem in GPUs/SIMD

- GPU uses SIMD pipeline to save area on control logic.
 - Group scalar threads into warps
- Branch divergence occurs when threads inside warps branch to different execution paths.

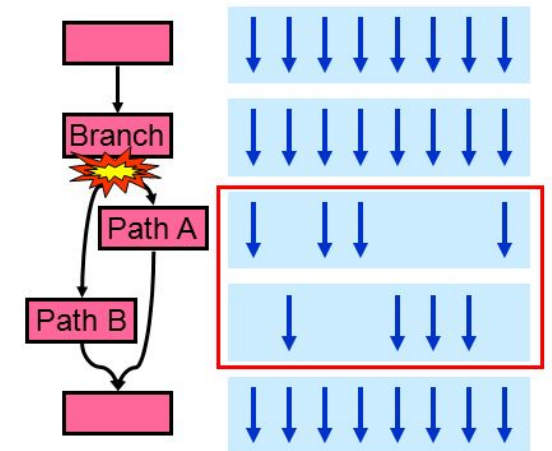

Wilson Peng et al. UBC

Medium learning example : Surrogate models for system performance optimization

Discriminative system model

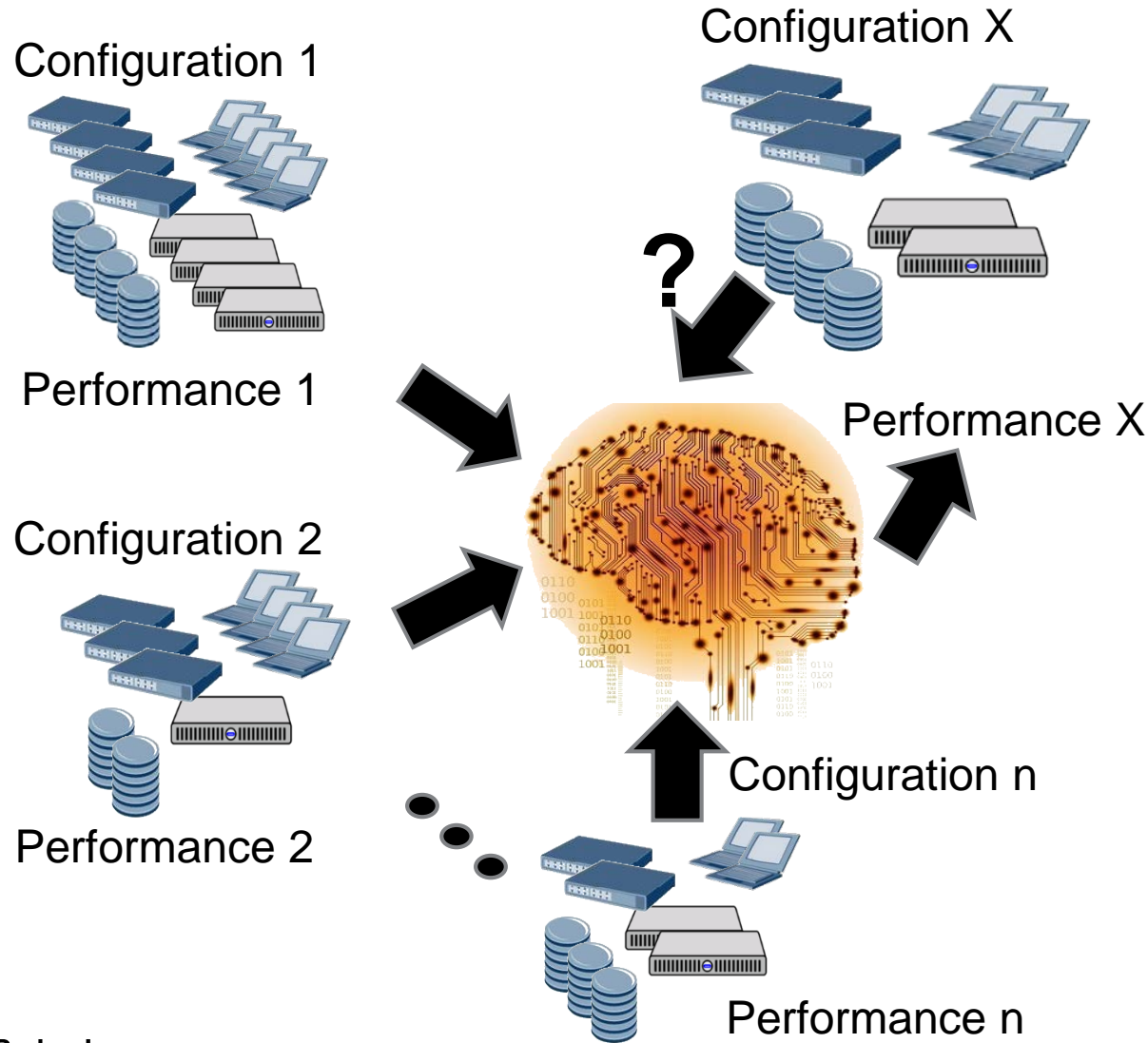

- Collect n samples of system configurations and observed performance
- Build a model to predict the performance
 - Neural network
 - Linear/non-linear regression
- In the future, given a configuration X, model predict performance X

Generative system model

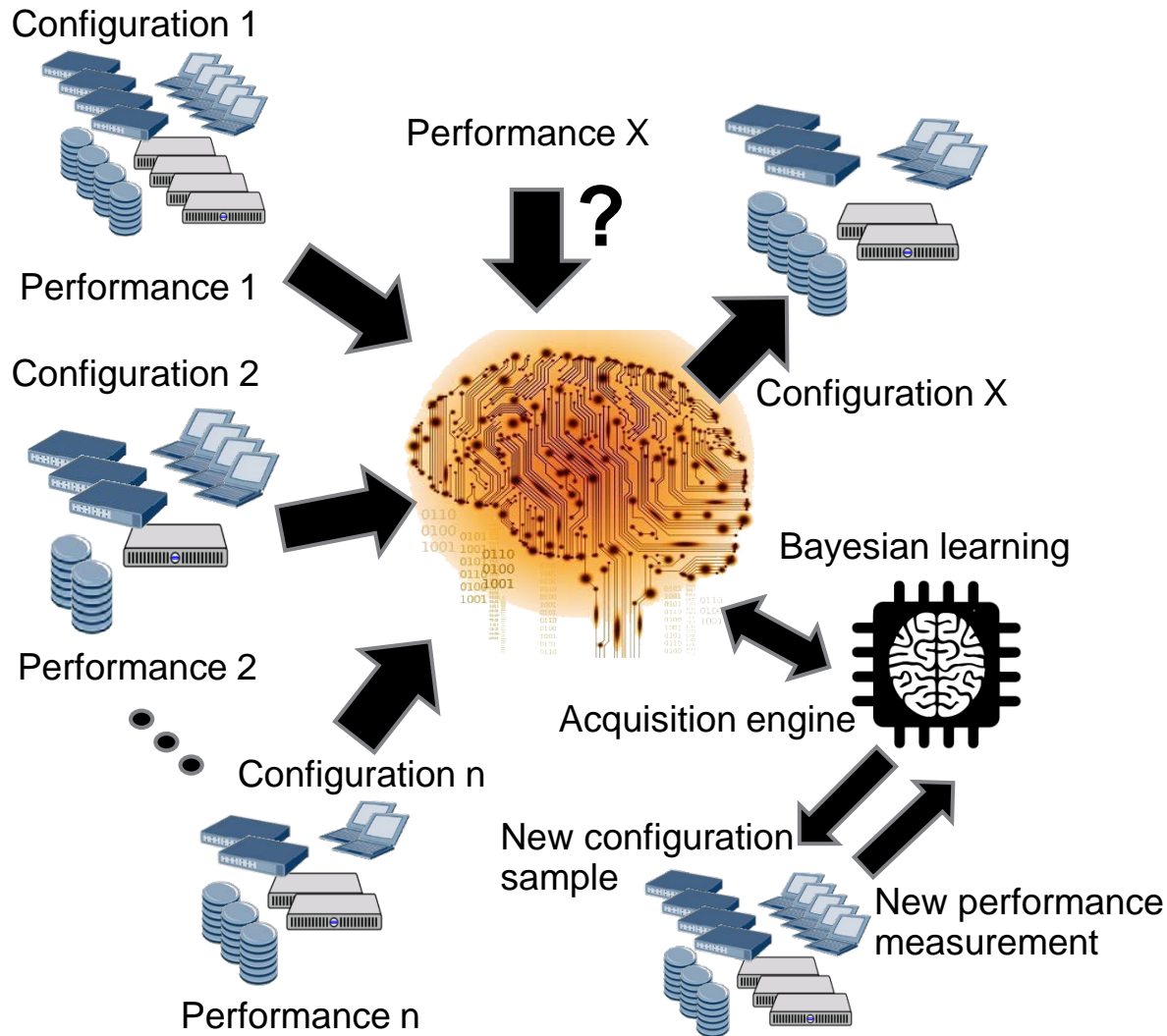

- Collect n samples of system configuration and performance
- Construct surrogate model and use Bayesian learning to construct additional configurations and performance measurement
- Keep iteration until target uncertainty is hit
- Given a new target performance, what is the optimal configuration to achieve, usually tie in with a cost function and optimize for the lowest cost

Principal component analysis and surrogate models

25 controlling taps in the 56G PAM SerDes is mapped into 4 principal component vectors that can cover 92% of solutions

Surrogate models based on 5000+ measured samples

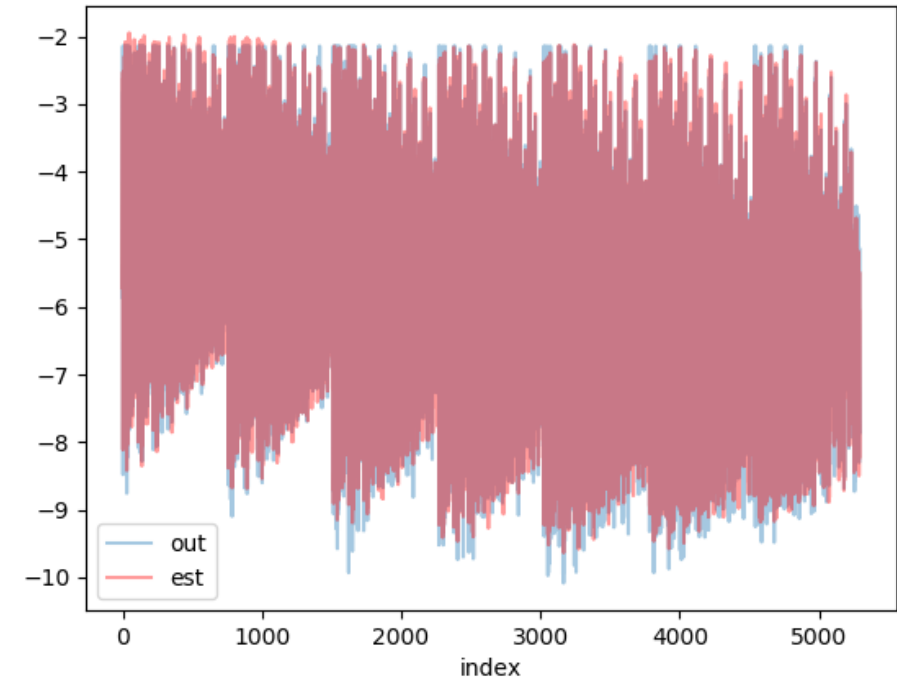
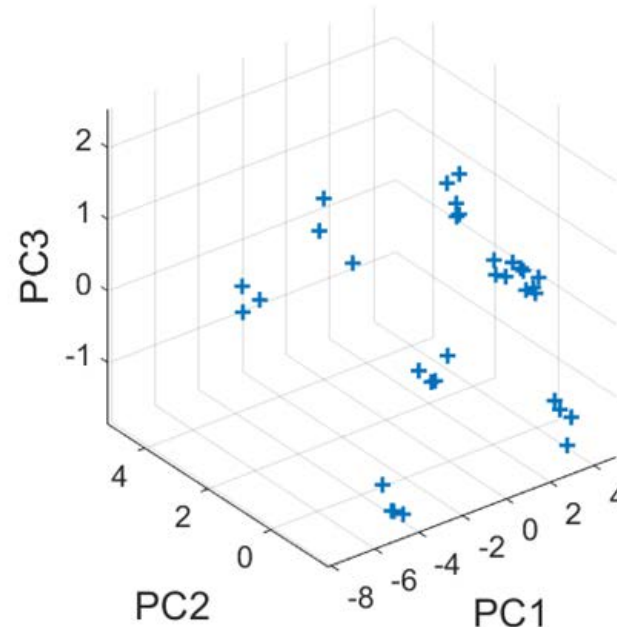
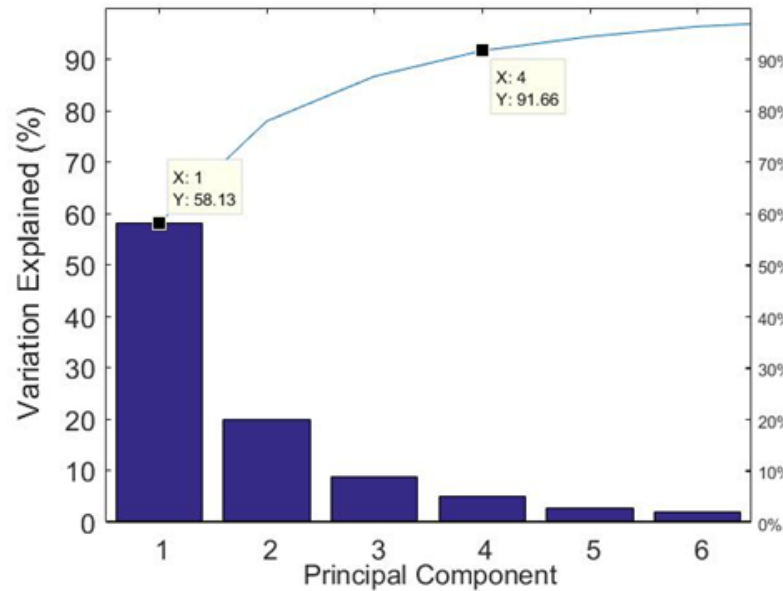

Zhu et al, DesignCon 2019

Recommended MATLAB package : Statistics and Machine Learning Toolbox

Accelerated 56G PAM channel optimization using PCA

Best fitness function versus generation.

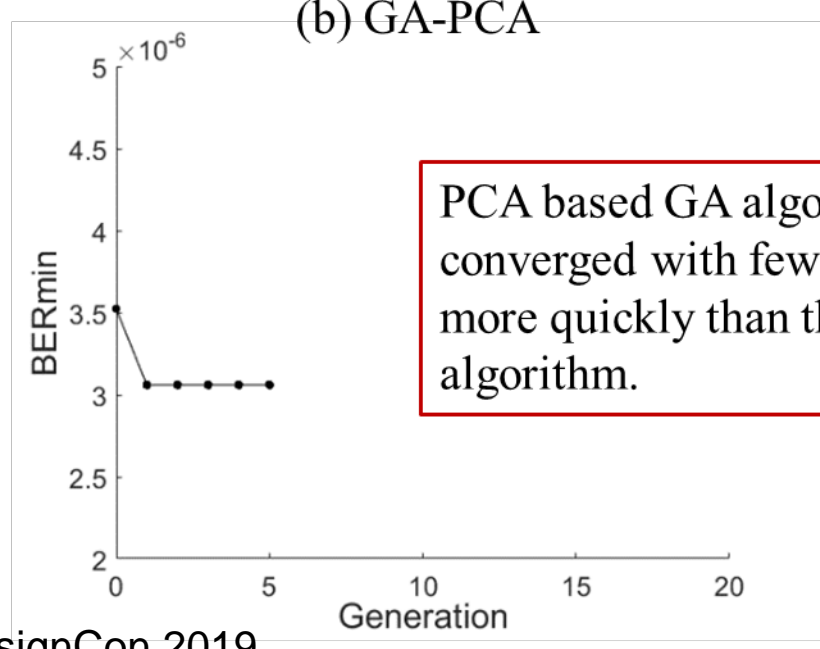
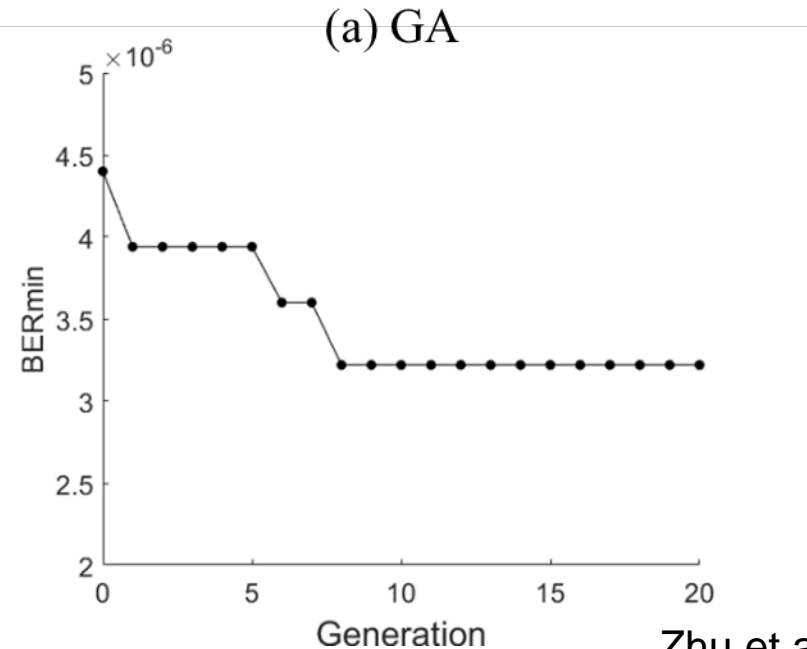

PCA based GA algorithm converged with fewer generations, more quickly than the general GA algorithm.

Zhu et al. DesignCon 2019

Recommended MATLAB Package : Global Optimization Toolbox

Deep learning example : High dimension resource demand forecast

High dimension resources demand forecast

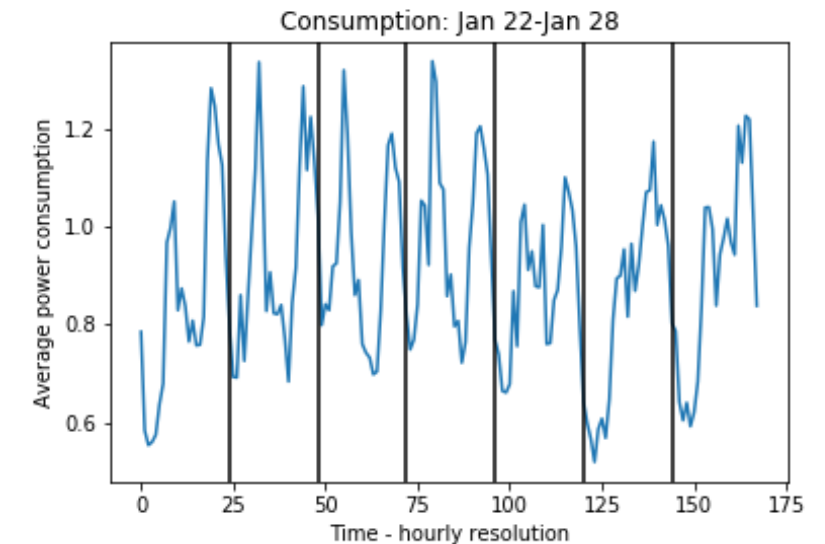
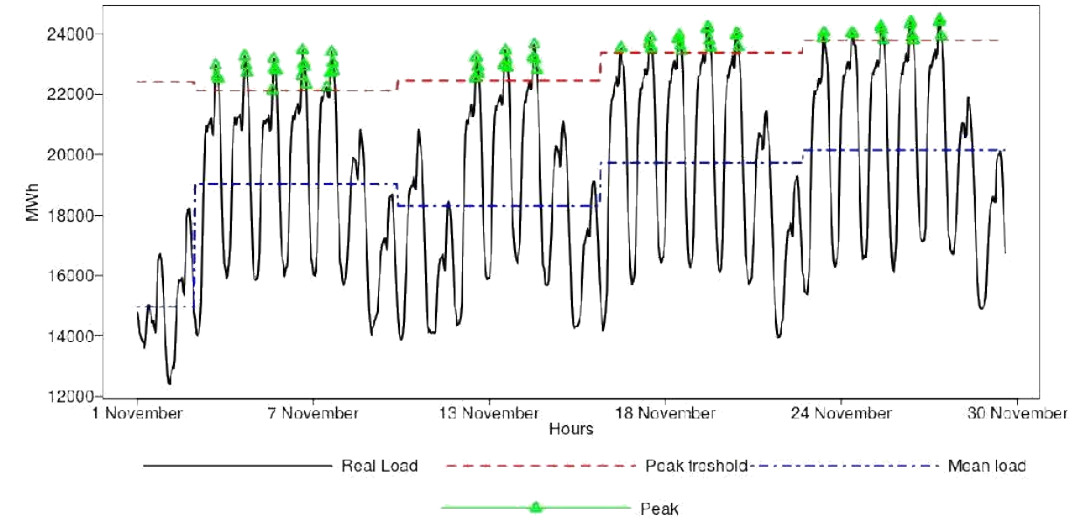
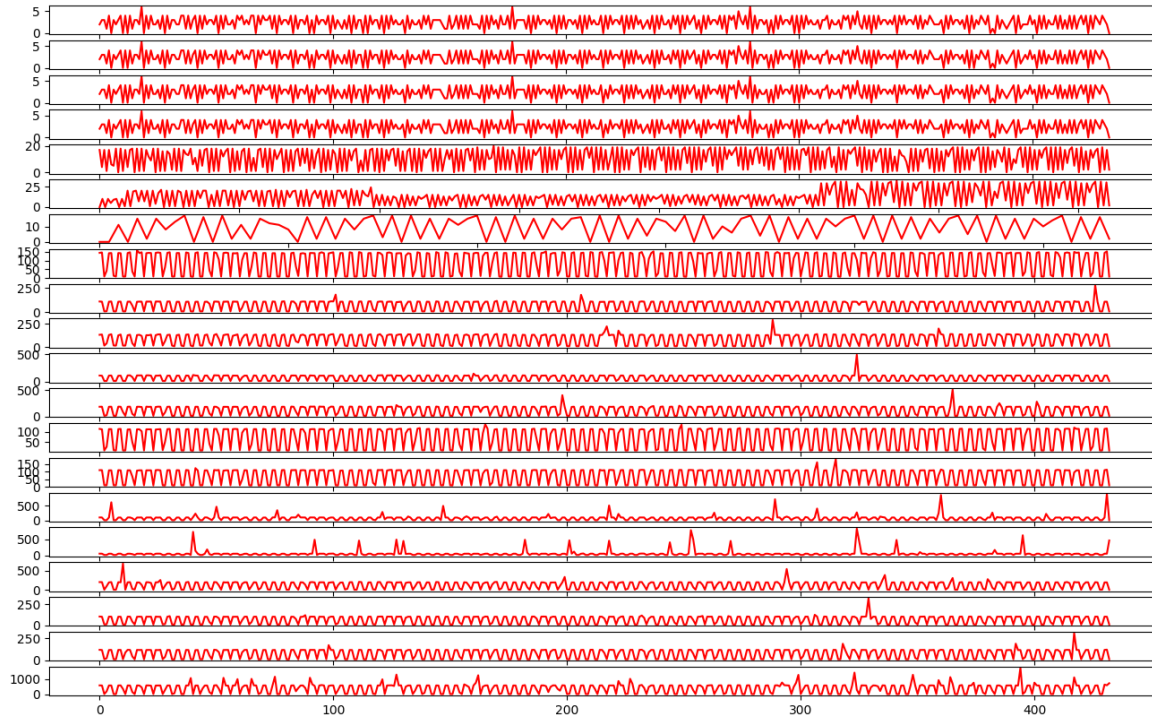

Many system resources show clusters of users and daily pattern

Time domain demand forecast

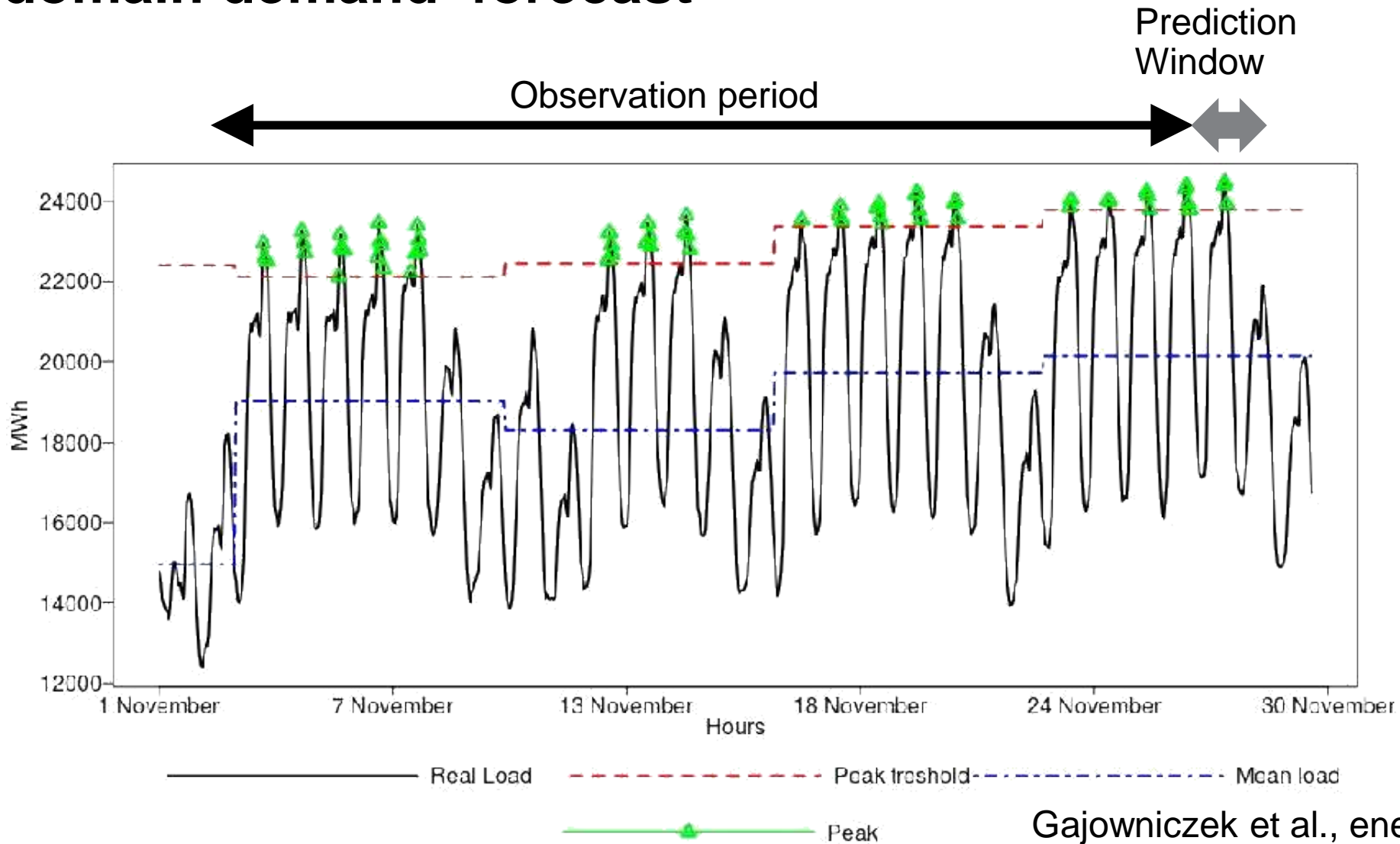

Gajowniczek et al., energies 2017

Thank you