





Optimizing cost with Simulation and Digital Twins

Carl Wouters



DID YOU KNOW?

Every third car in the world
is assembled with
products and solutions
from Atlas Copco.





DID YOU KNOW?

Oil-free compressors
from Atlas Copco
are used to process coffee*
with the highest demands
on purity and energy efficiency.

*(*We helped making the mug too)*





DID YOU KNOW?

Compressors from Atlas Copco
are used to brew 50% of
all industrially produced beer
in the world.

Atlas Copco in figures



Customers in **180** countries



34000 employees in **90** countries



Established in **1873** Stockholm, Sweden



Turnover of nearly **86** BSEK / **9** BEURO



A decentralized Group with **4** business areas

Organization

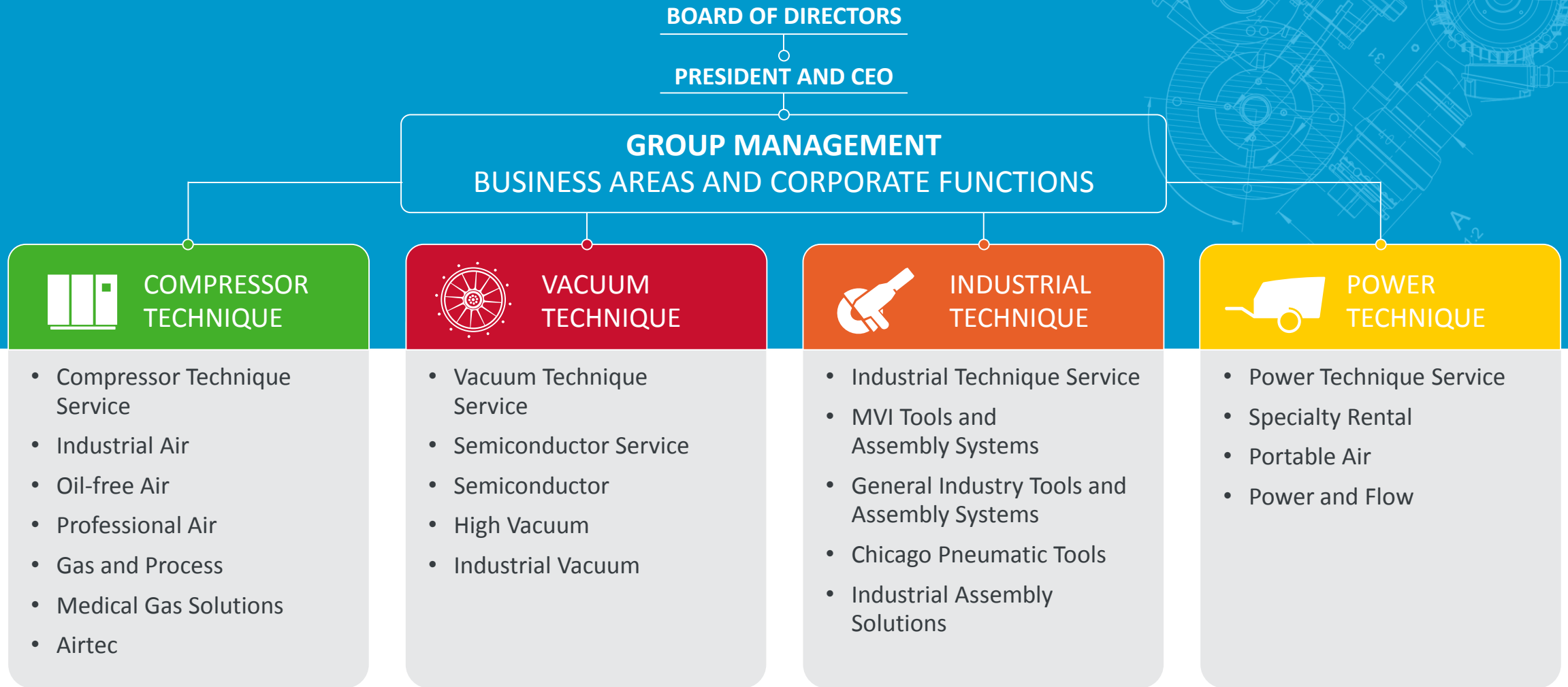



Atlas Copco

ZR 160 VSD+

The ZR 160 VSD+

- One of the **most efficient** Oil-free screw compressor in the world in its power range
- **Hundreds of Atlas Copco employees** are involved in development, production, service and marketing
- All key components are completely **engineered by Atlas Copco** (i.e. Compressor Elements, Coolers, PM motors, Converters...)
- **> 50 sensors** for control, reliability, safety, predictive maintenance
- Able to operate **24/7**

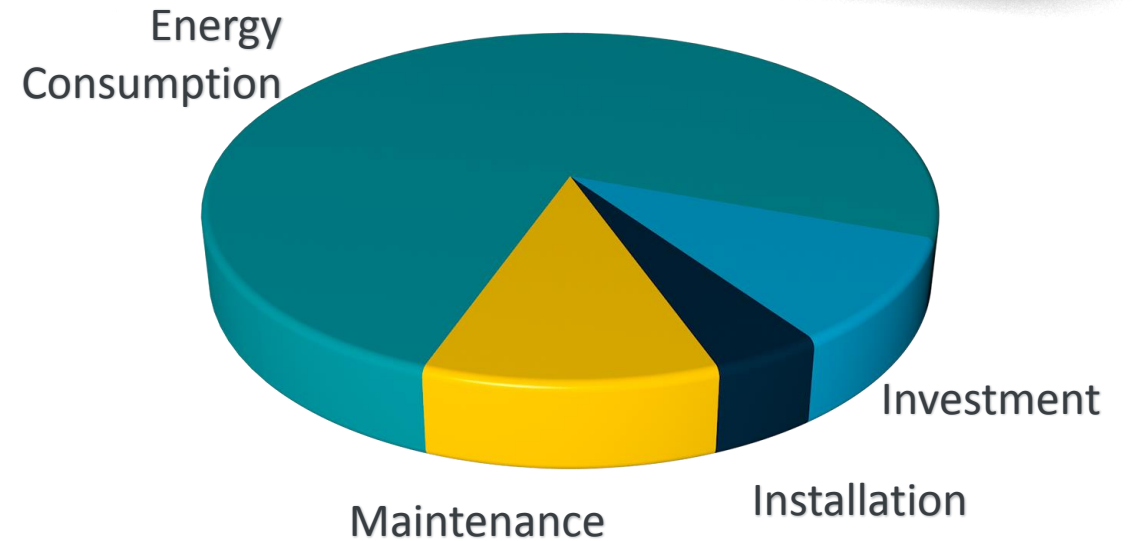
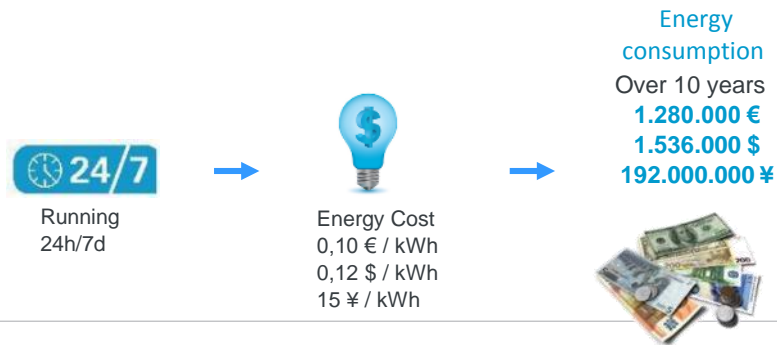
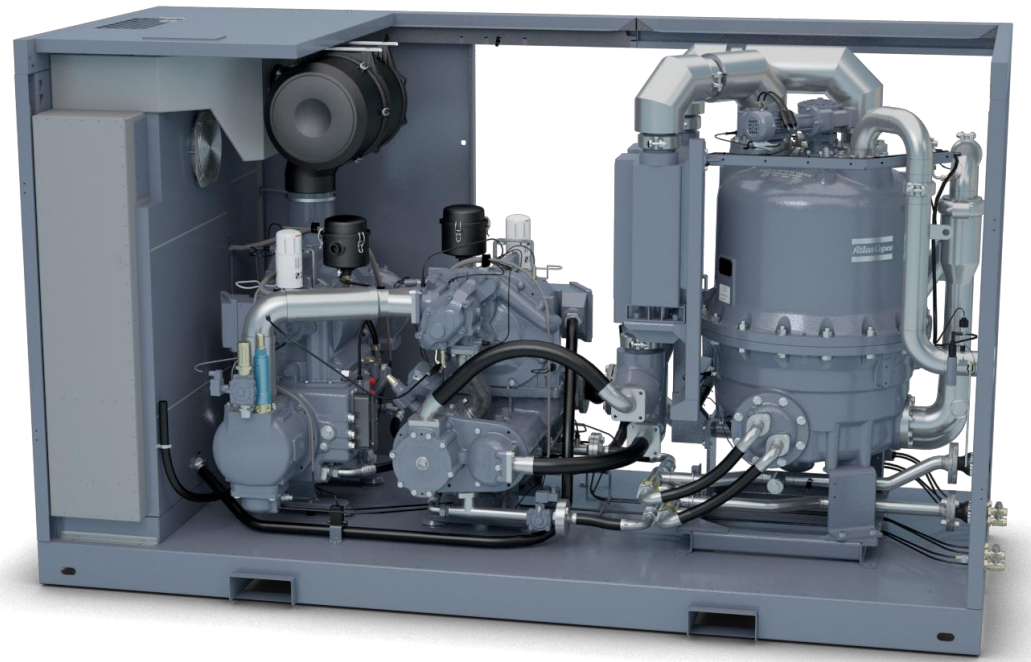

Challenges



- **Mature market**
- **Shorter Time to Market**
- **Cross divisional** development
- Almost **all components are redesigned** to improve reliability and efficiency while keeping total development, production and service costs in account
- **Self adaptive controller algorithm** to optimize efficiency in full working range
- **High product variability**, tens of thousands possible configuration options in Oil-free screw compressor portfolio
- **High product reliability**, > 60.000 running hours

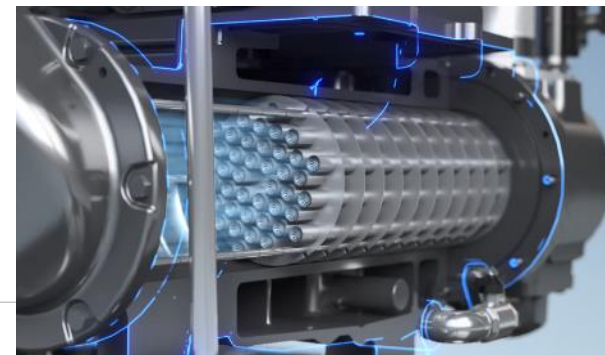
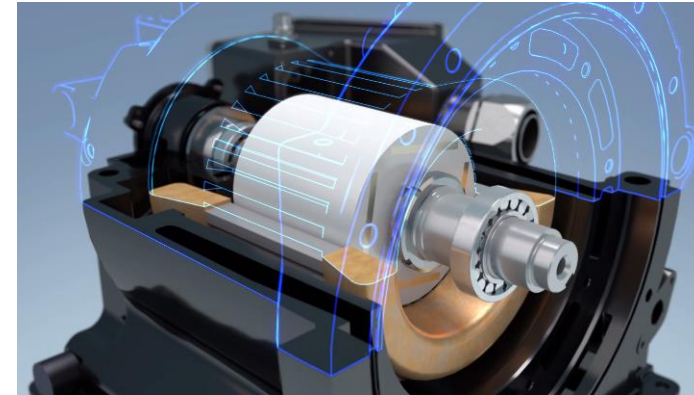

Innovation

Increase customer energy efficiency by 20% by 2020

Digital Twin?

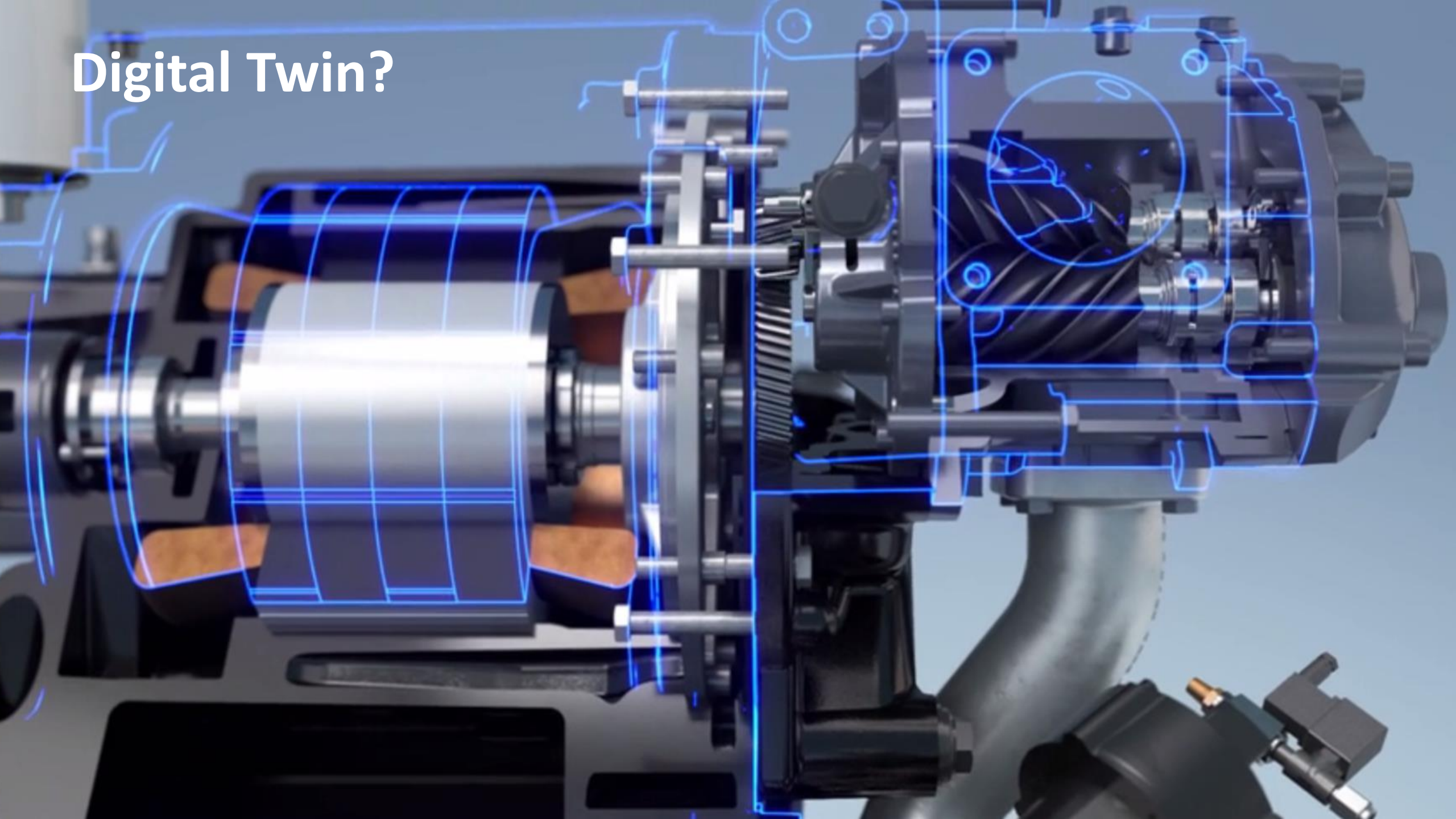

Digital Twin in Atlas Copco and Single source of truth

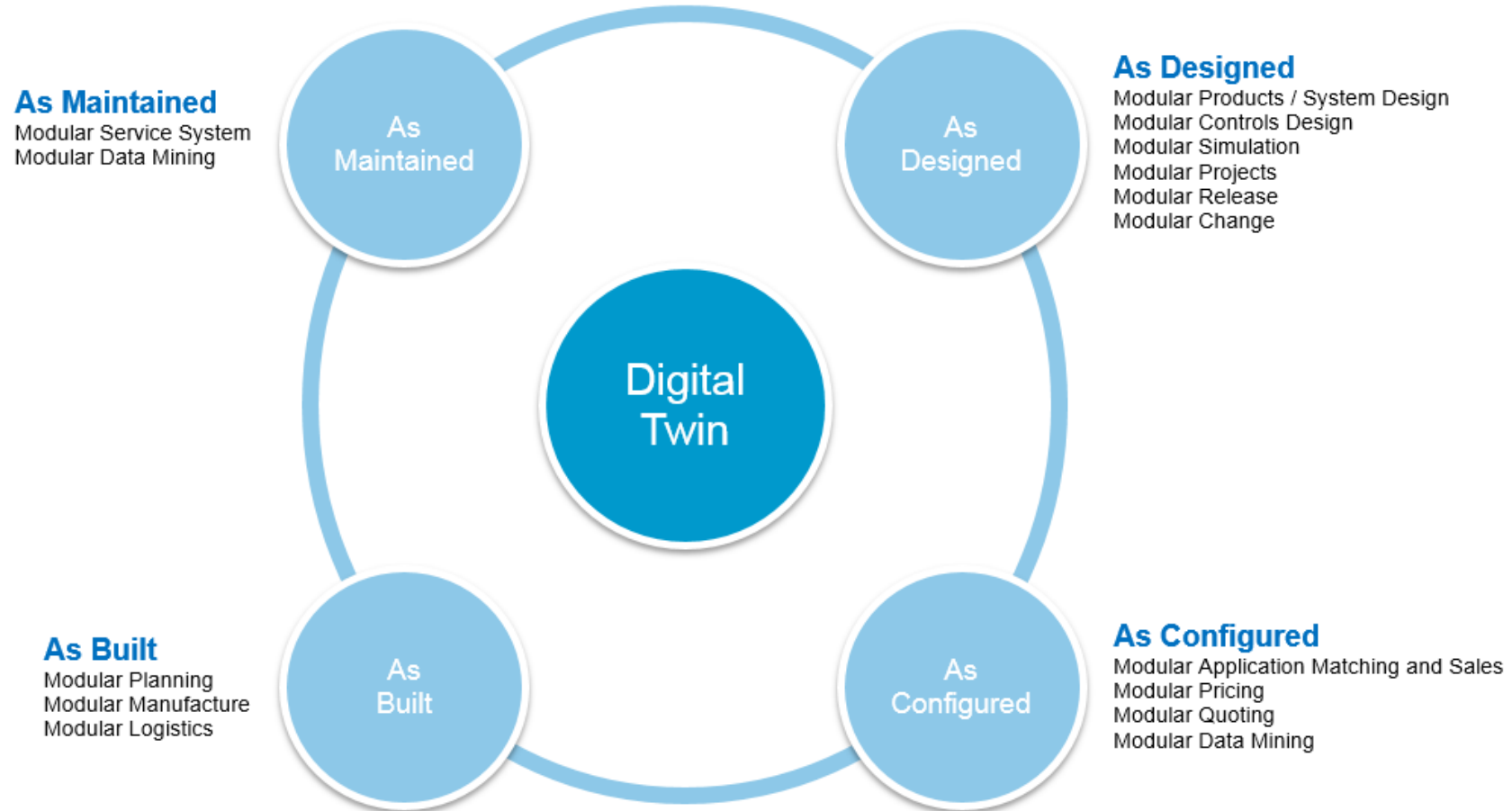

Atlas Copco Model Based Engineering Platform

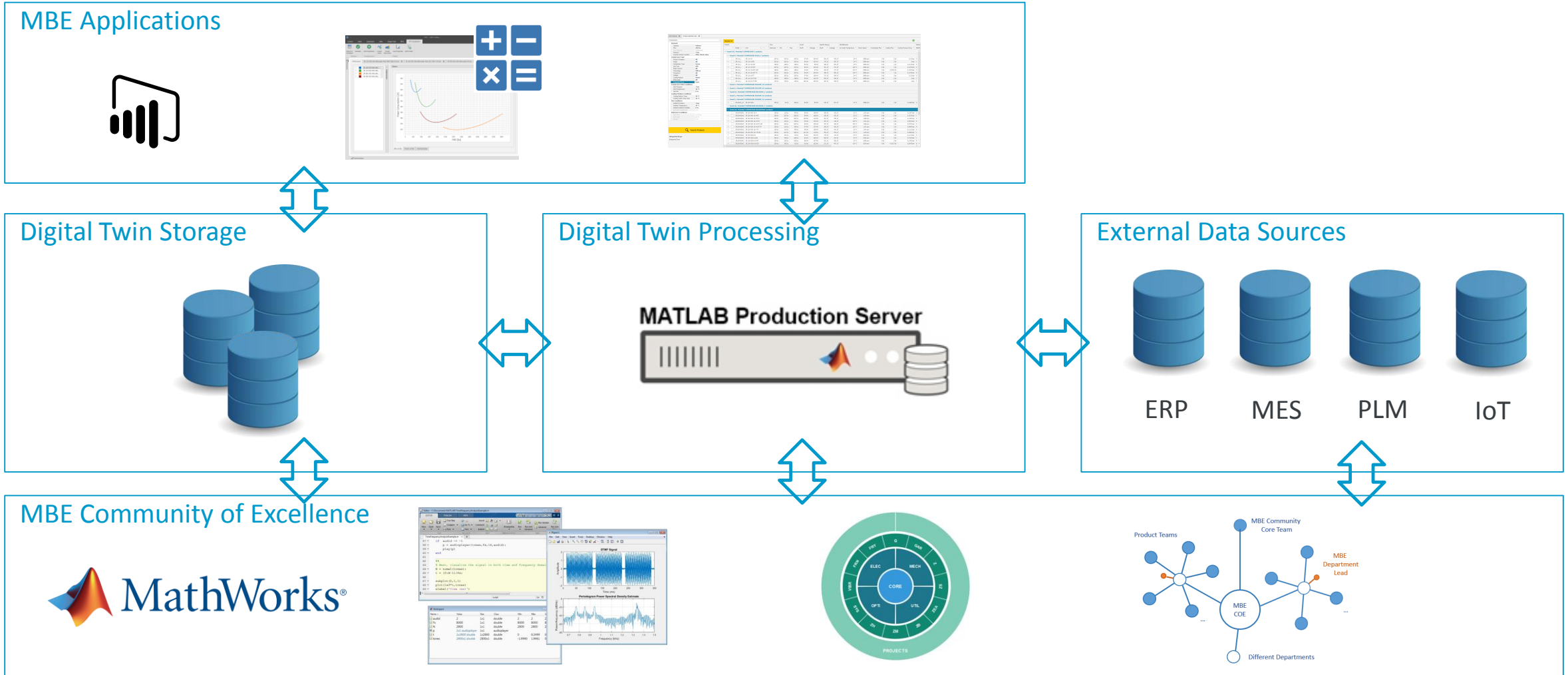

As Designed: MBE Community of Excellence

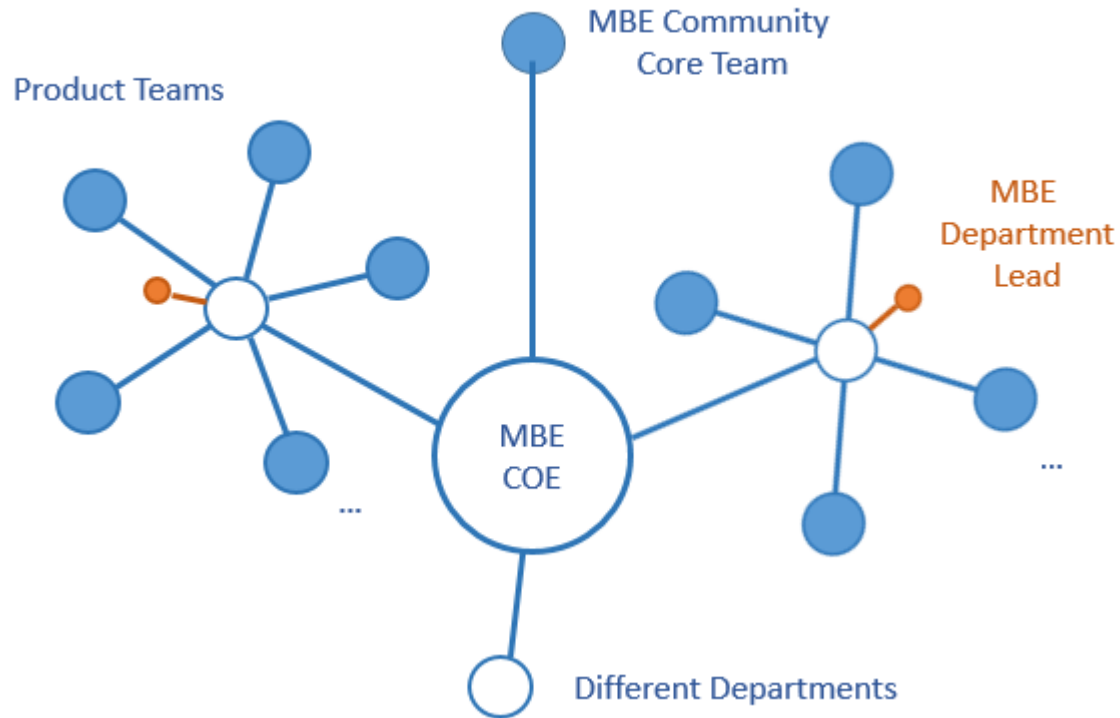

- **Open information sharing** mentality within Compressor Technique, using **MATLAB** as a platform
- Community **wants** to be integrated in **all product teams worldwide**
- **Knowledge sharing platform** for Calculations, Simulations, Data Analytics, Controller Algorithms
 - Object oriented MATLAB libraries
 - Integration of non-MATLAB code
 - GIT repositories, Source Control
 - Trainings
- Each product team is responsible and takes ownership for their implementations
- Standardization on tools

As Designed: MBE Framework

Physical Framework

“As a calculation engineer, I want to simulate dynamic behaviour of my system to optimize my components.”

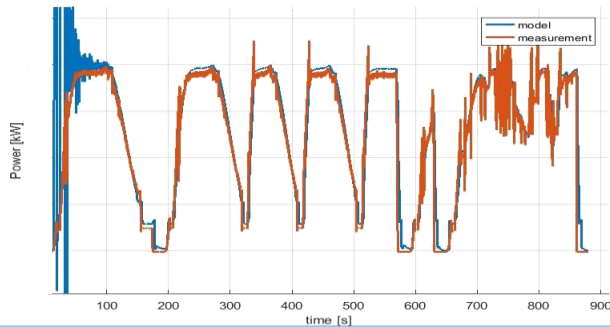

Core Framework

“As a calculation engineer, I want to find optimal gear ratio's and element sizings.”

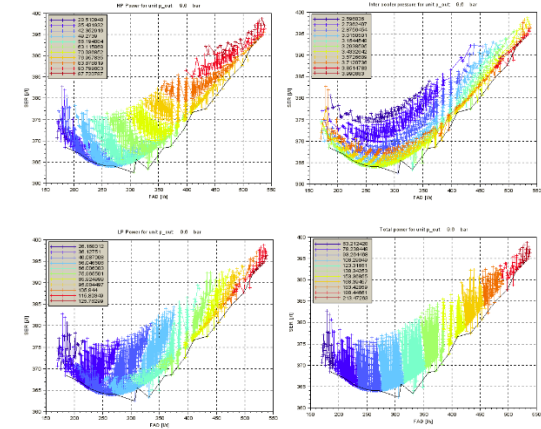

Interface Framework

“As a marketer, I want to have easy access to the validated engineering data to create my technical data sheets.”

Technical data: ZR 160 VSD+10.4

Product definition	
Model	ZR 160 VSD+
Pressure variant	10.4 bar
Integrated dryer	Flack
Frequency	50 Hz
Reference conditions	
Absolute inlet pressure	1 bar(a)
Relative humidity	0%
Air inlet temperature	20 °C
Cooling water inlet temperature	20 °C
Cooling water temperature rise	15 °C
Effective working pressure	7 bar(g)
Motor shaft speed(rpm)	6316 rpm
Performance data ¹⁾	
Maximum working pressure	10.4 bar(g)
Free air delivery (at maximum volume flow rate)	
- Total electrical power input	
- Total specific energy requirements (SER)	
Free air delivery (at 50% of volume flow range)	
- Total electrical power input	
- Total specific energy requirements (SER)	
Free air delivery (at 25% of volume flow range)	
- Total electrical power input	
- Total specific energy requirements (SER)	
Free air delivery (at 25% of volume flow range)	
- Total electrical power input	
- Total specific energy requirements (SER)	
Free air delivery (at minimum volume flow rate)	
- Total electrical power input	
- Total specific energy requirements (SER)	
Effective working pressure (1)	
Free air delivery (at maximum volume flow rate)	

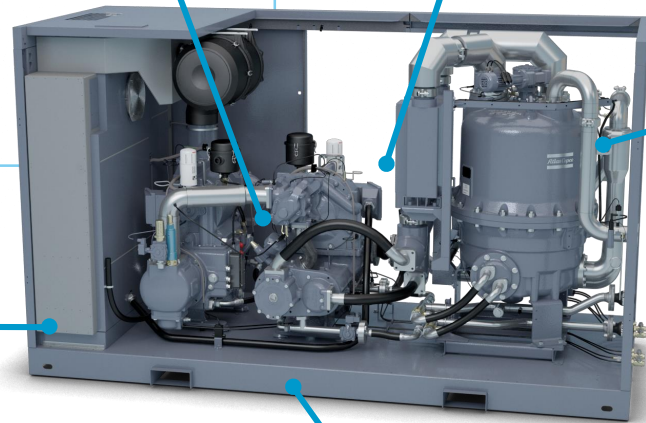

Community Tools

Software platform enabling community development
Wiki, bug trackers, source control,...

Controller Framework

“As a control engineer, I want to simulate the effect of my control strategy on the system.”

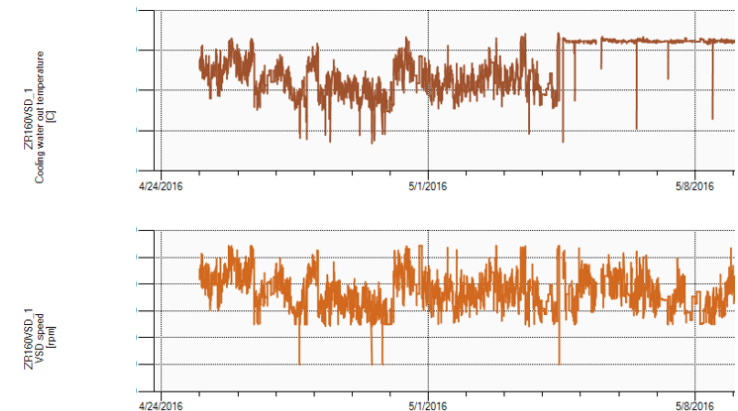

As Designed: Digital Twin

Thomas Kaiser, SAP Senior Vice President of IoT: “Digital twins are becoming a business imperative, covering the entire lifecycle of an asset or process and forming the foundation for connected products and services.”

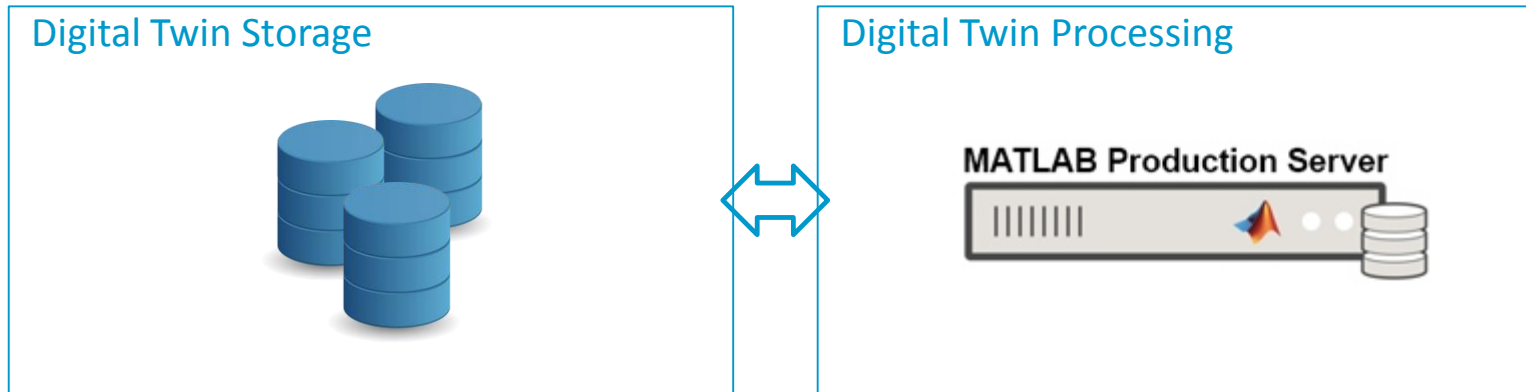

Model Integration

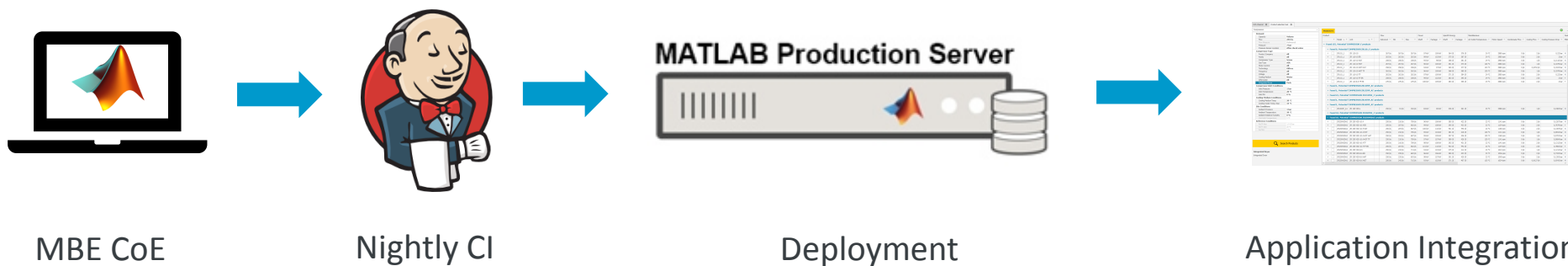

Compressors

Demand

Capacity: 250 l/s
 Flow: 250 l/s
 Pressure: 7 bar
 Pressure Sensor Location: After check valve

Compressor Type

Product Company: All
 Family: All
 Compressor Type: Screw
 Gas Type: AIR
 Motor Control: All
 Technology: OilFree
 Frequency: All
 Voltage: All
 Cooling Medium: Water
 Aftercooler: All
 Integrated Dryer: Pack

Compressor Inlet Conditions

Inlet Pressure: 1 bar
 Inlet Temperature: 20 °C
 Inlet RH: 0 %

Cooling Medium Conditions

Cooling Medium Temp.: 20 °C
 Cooling Water Temp. Rise: 15 °C

Site Conditions

Ambient Pressure: 1 bar
 Ambient Temperature: 20 °C
 Ambient Relative Humidity: 0 %
 Wet Bulb Temperature: 5 °C

Reference Conditions

Ref P Atm: 1,013 bar
 Ref T Atm: 20 °C
 Ref RH: 0 %

As Configured

PRODUCTS

Product	Model	Unit	Flow			Power		Specific Energy		Miscellaneous				Feature	
			Delivered	Min	Max	Shaft	Package	Shaft	Package	Air Outlet Temperature	Motor Speed	Condensate Flow	Cooling Flow		Cooling Pressure Drop
Found 9, Potential 'COMPRESSOR ZR110_1' products															
<input type="checkbox"/>	ZR110_1	ZR 110-10	267 l/s	267 l/s	267 l/s					24 °C	2980 rpm	0 l/s	2 l/s	0,22 bar	N
<input type="checkbox"/>	ZR110_1	ZR 110-10 ER	263 l/s	263 l/s	263 l/s					24 °C	2980 rpm	0 l/s	2 l/s	2 bar	Y
<input type="checkbox"/>	ZR110_1	ZR 110-10 HAT	258 l/s	258 l/s	258 l/s					24 °C	2980 rpm	0 l/s	1 l/s	0,2116 bar	N
<input type="checkbox"/>	ZR110_1	ZR 110-10 HOT	267 l/s	267 l/s	267 l/s					120 °C	2980 rpm	0 l/s	1 l/s	0,1079 bar	N
<input type="checkbox"/>	ZR110_1	ZR 110-10 HOT HAT	258 l/s	258 l/s	258 l/s					123 °C	2980 rpm	0 l/s	0,9752 l/s	0,1022 bar	N
<input type="checkbox"/>	ZR110_1	ZR 110-10 HOT TF	262 l/s	262 l/s	262 l/s					120 °C	2980 rpm	0 l/s	1 l/s	0,1079 bar	N
<input type="checkbox"/>	ZR110_1	ZR 110-10 TF	262 l/s	262 l/s	262 l/s					24 °C	2980 rpm	0 l/s	2 l/s	0,22 bar	N
<input type="checkbox"/>	ZR110_1	ZR 110-10 TF ER	258 l/s	258 l/s	258 l/s					24 °C	2980 rpm	0 l/s	2 l/s	2 bar	Y
<input type="checkbox"/>	ZR110_1	ZR 110-8.6 TF ER	276 l/s	276 l/s	276 l/s					24 °C	2980 rpm	0 l/s	2 l/s	2 bar	Y

Found 1, Potential 'COMPRESSOR ZR110VP_A1' products

Found 1, Potential 'COMPRESSOR ZR132VP_A1' products

Found 21, Potential 'COMPRESSOR ZR132VSD_1' products

Found 1, Potential 'COMPRESSOR ZR145VP_A1' products

Found 1, Potential 'COMPRESSOR ZR160VP_A1' products

Found 44, Potential 'COMPRESSOR ZR160VSD_1' products

Found 18, Potential 'COMPRESSOR ZR250VSDA2' products

<input type="checkbox"/>	ZR250VSDA2	ZR 250 VSD-10.4
<input type="checkbox"/>	ZR250VSDA2	ZR 250 VSD-10.4 ER
<input type="checkbox"/>	ZR250VSDA2	ZR 250 VSD-10.4 HAT
<input type="checkbox"/>	ZR250VSDA2	ZR 250 VSD-10.4 HOT
<input type="checkbox"/>	ZR250VSDA2	ZR 250 VSD-10.4 HOT HAT
<input type="checkbox"/>	ZR250VSDA2	ZR 250 VSD-10.4 HOT TF
<input type="checkbox"/>	ZR250VSDA2	ZR 250 VSD-10.4 TF
<input type="checkbox"/>	ZR250VSDA2	ZR 250 VSD-10.4 TF ER
<input type="checkbox"/>	ZR250VSDA2	ZR 250 VSD-8.6
<input type="checkbox"/>	ZR250VSDA2	ZR 250 VSD-8.6 ER
<input type="checkbox"/>	ZR250VSDA2	ZR 250 VSD-8.6 HAT
<input type="checkbox"/>	ZR250VSDA2	ZR 250 VSD-8.6 HOT

Search Products

Integrated Dryer
Integrated Dryer

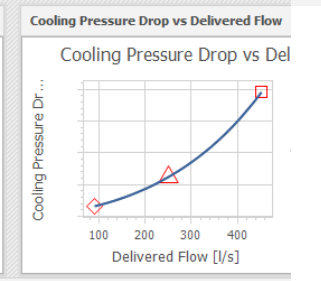
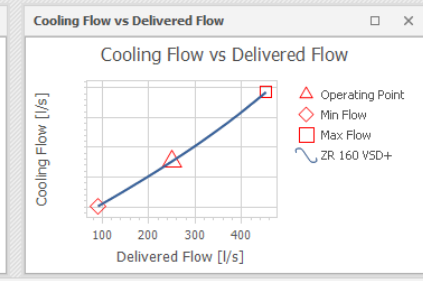
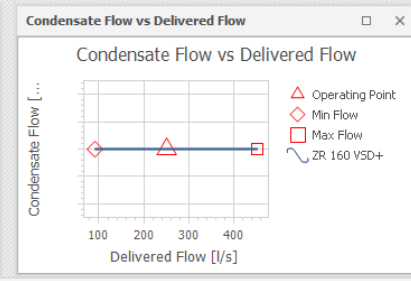
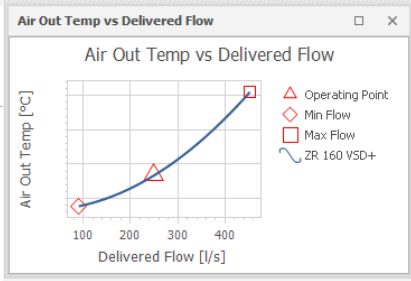
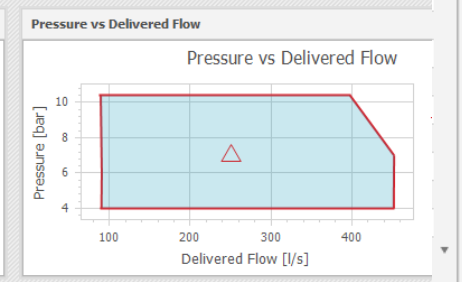
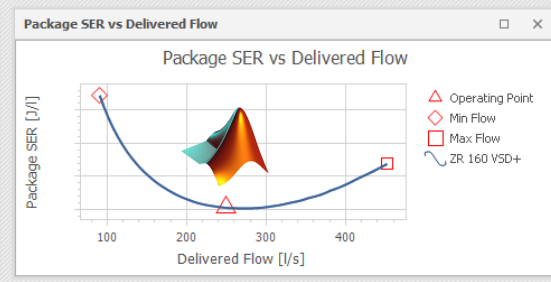
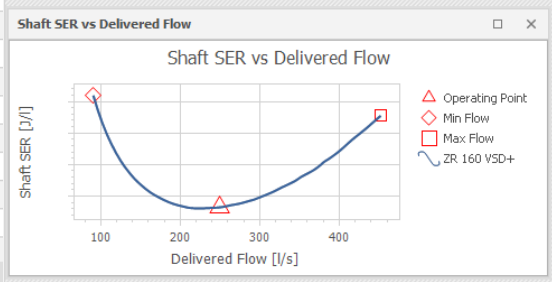
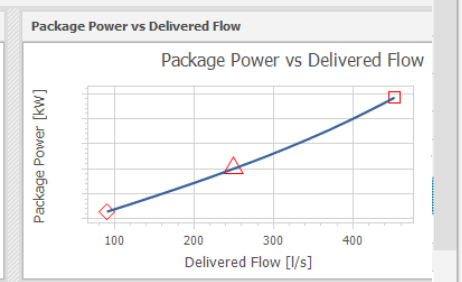
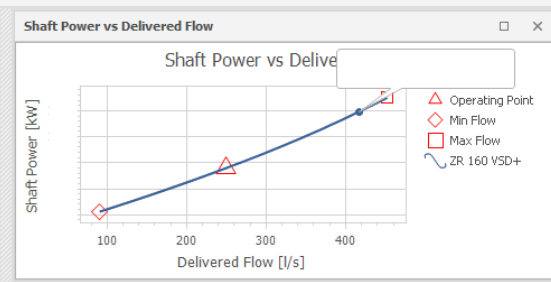
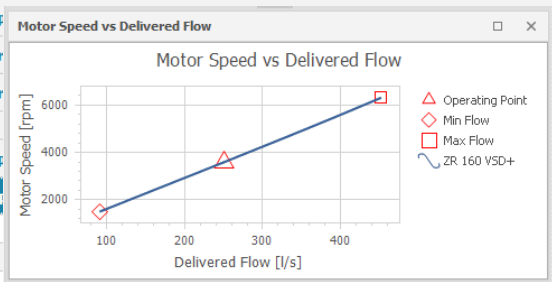

Basic product General Options Request article numbers and instruction book

Model	ZR 160 VSD+
Integrated dryer <small>PDP sensor is delivered as standard</small>	Pack
Frequency	50 Hz
Supply voltage	400V
Electrical approval	IEC
Working pressure	10.4 bar
Pressure vessel approval	CE
Flanged connection	DIN flanges

Next >

Basic product General Options Request article numbers and instruction book

Request article numbers [Instruction Book](#)

[Technical Datasheet](#) [Product Description](#)

< Previous

ZR 90-160 VSD+



Country of destination Belgium
 Model ZR 160 VSD+
 Integrated dryer Pack
 Frequency 50 Hz
 Supply voltage 400V
 Electrical approval IEC
 Working pressure 10.4 bar
 Pressure vessel approval CE

Technical data: ZR 160 VSD+-10.4

Product definition	
Model	ZR 160 VSD+
Pressure variant	10.4 bar
Integrated dryer	Pack
Frequency	50 Hz

Reference conditions	
Absolute inlet pressure	1 bar(a)
Relative humidity	0 %
Air inlet temperature	20 °C
Cooling water inlet temperature	20 °C
Cooling water temperature rise	15 °C
Effective working pressure	7 bar(g)
Motor shaft speed(rpm)	6316 rpm

Performance data*1	
Maximum working pressure	10.4 bar(g)
Free air delivery (at maximum volume flow rate)	100.0 m³/min
- Total electrical power input	175.0 kW
- Total specific energy requirements (SER)	1.75 kWh/m³
Free air delivery (at 75% of volume flow range)	75.0 m³/min
- Total electrical power input	130.0 kW
- Total specific energy requirements (SER)	1.73 kWh/m³
Free air delivery (at 50% of volume flow range)	50.0 m³/min
- Total electrical power input	107.0 kW
- Total specific energy requirements (SER)	2.14 kWh/m³
Free air delivery (at 25% of volume flow range)	25.0 m³/min
- Total electrical power input	77.0 kW
- Total specific energy requirements (SER)	3.08 kWh/m³
Free air delivery (at minimum volume flow rate)	10.4 m³/min
- Total electrical power input	49.0 kW
- Total specific energy requirements (SER)	4.71 kWh/m³
Effective working pressure (1)	10.4 bar(g)
Free air delivery (at maximum volume flow rate)	100.0 m³/min

As Produced

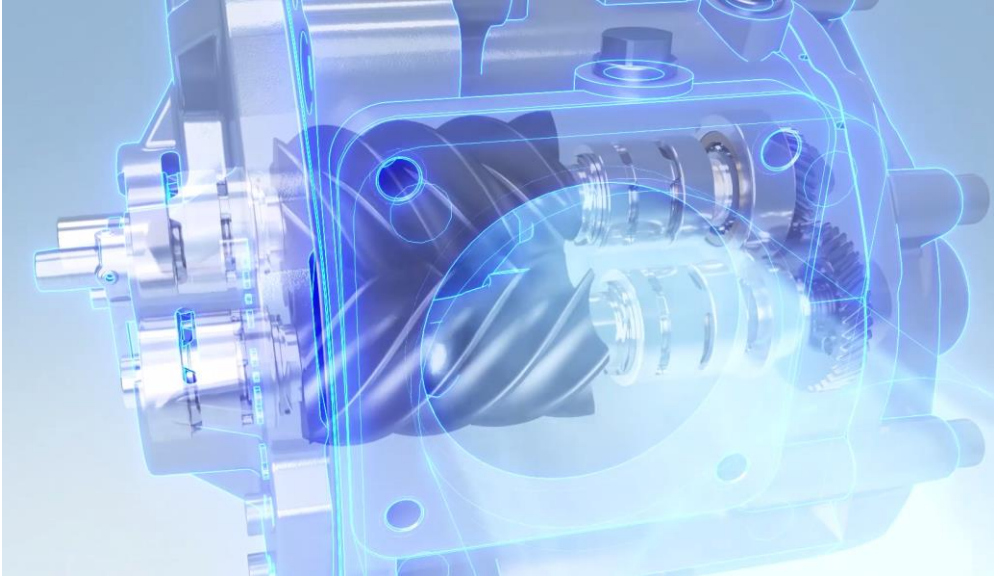

- **Revolutions:** 3.000 – 35.000 rpm
- **Tolerances:** 10 – 20 micrometer
- **Power Density:** 0.62 kilogram / kilowatt
- **Lifetime:** > 60.000 running hours

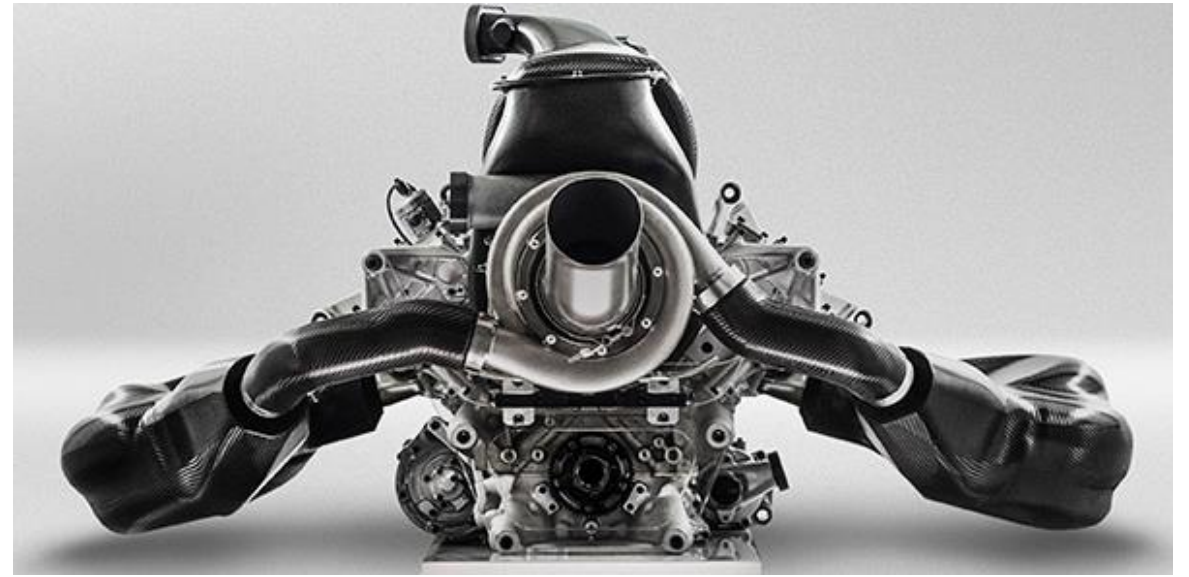

- **Revolutions:** < 18.000 rpm
- **Tolerances:** micrometers
- **Power Density:** 0.18 kilogram / kilowatt
- **Lifetime:** +/- 20 running hours

*Racecar Engineering

As Produced: Connectivity

The New World: Industrie 4.0

- Flexible systems and machines
- Functions are distributed throughout the network
- Participants interact across hierarchy levels
- Communication among all participants
- Product is part of the network

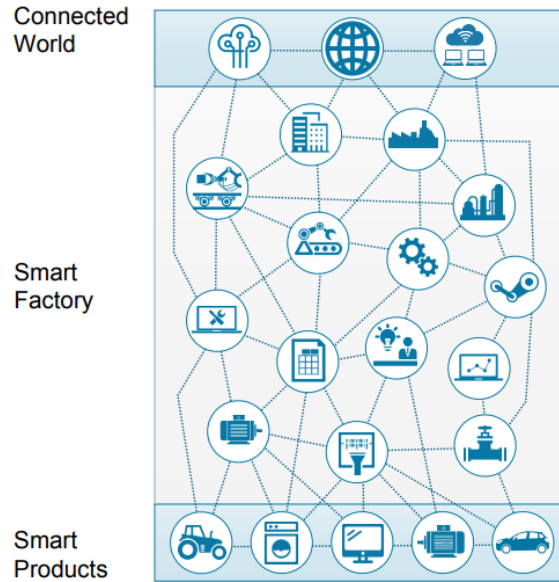

M2M Communication Landscape

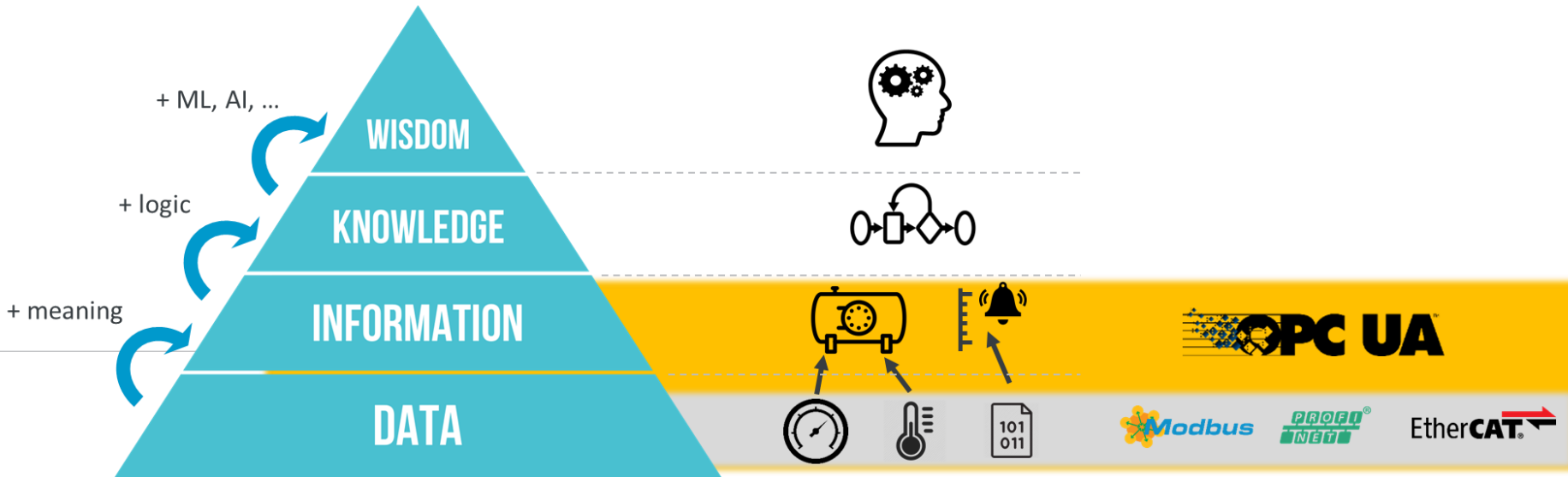
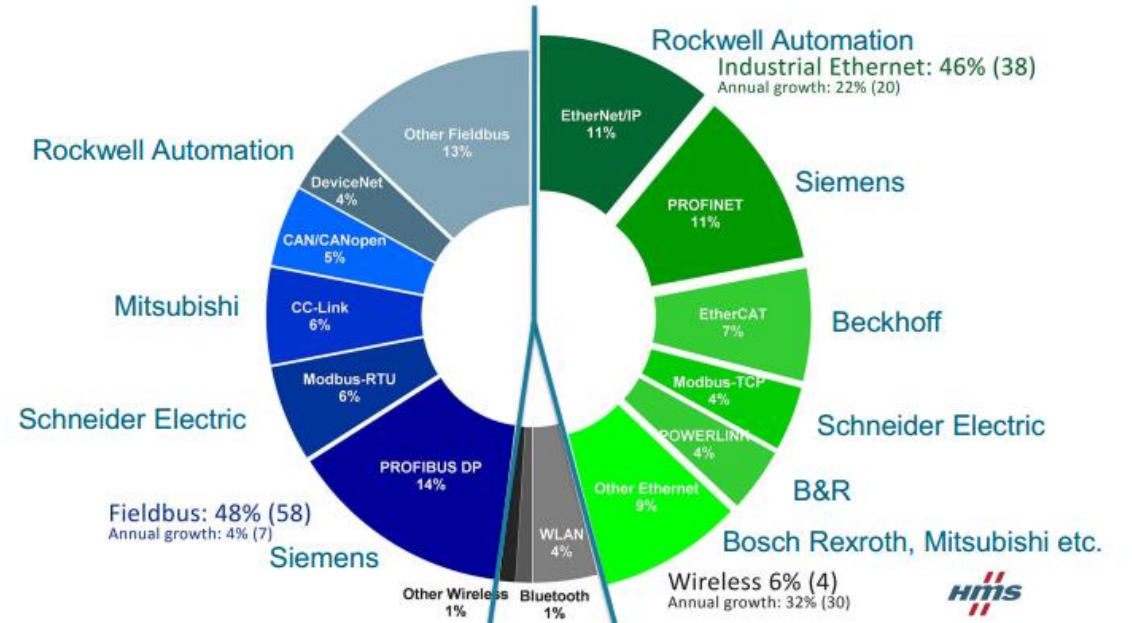

As Produced: Industry 4.0

Bill of Material



Tactile measurement

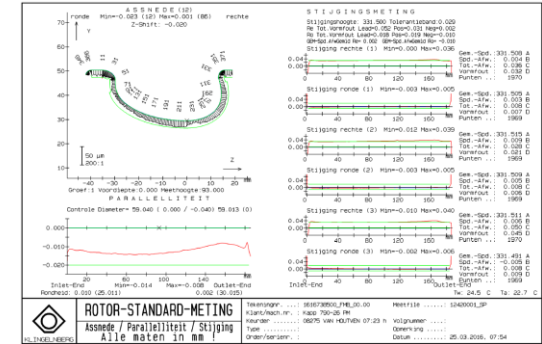

Performance Models & Measurements

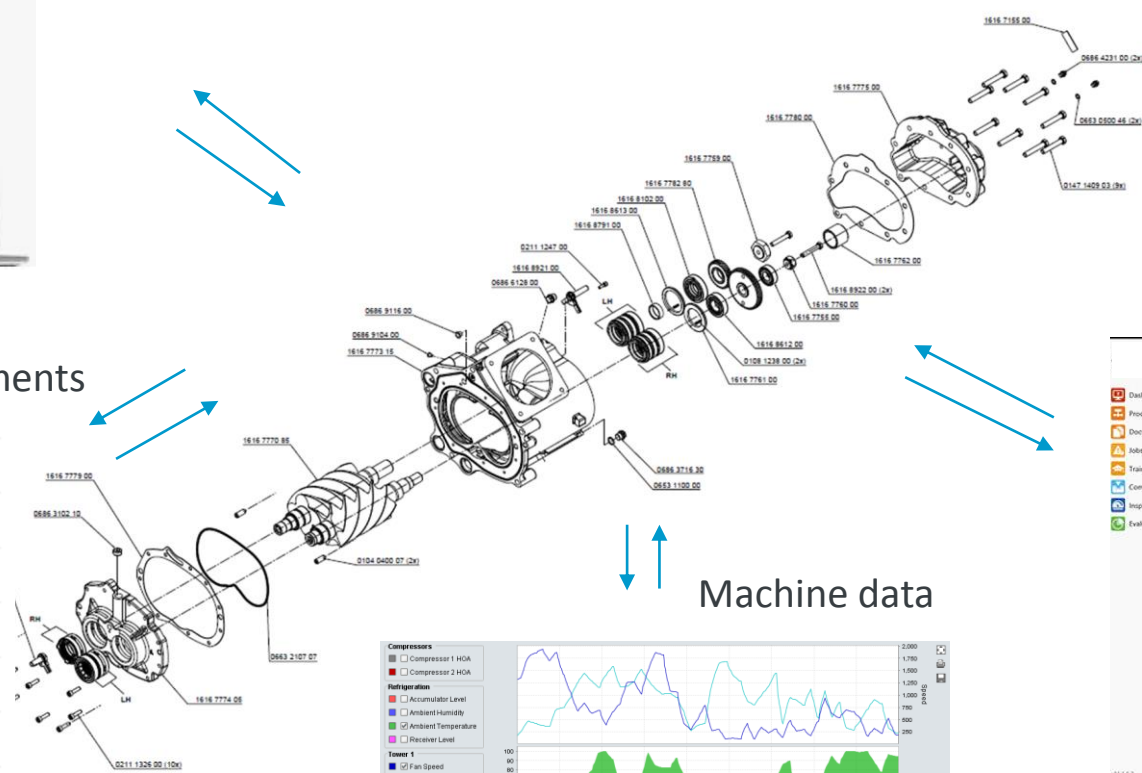
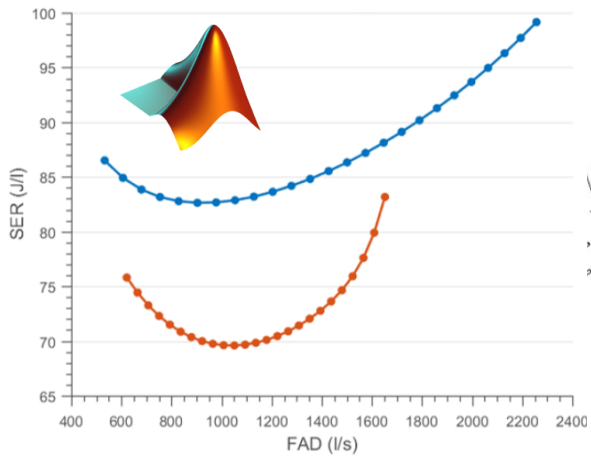

Machine data

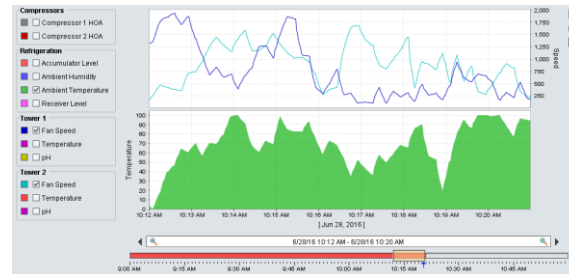

Quality

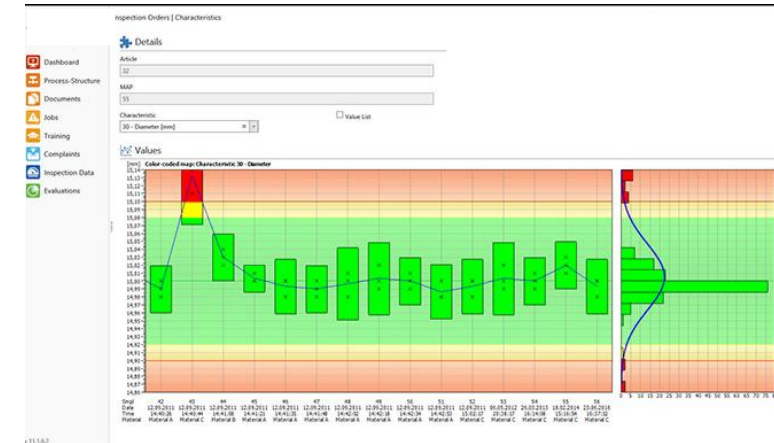

As Maintained: > 120.000 Machines Connected

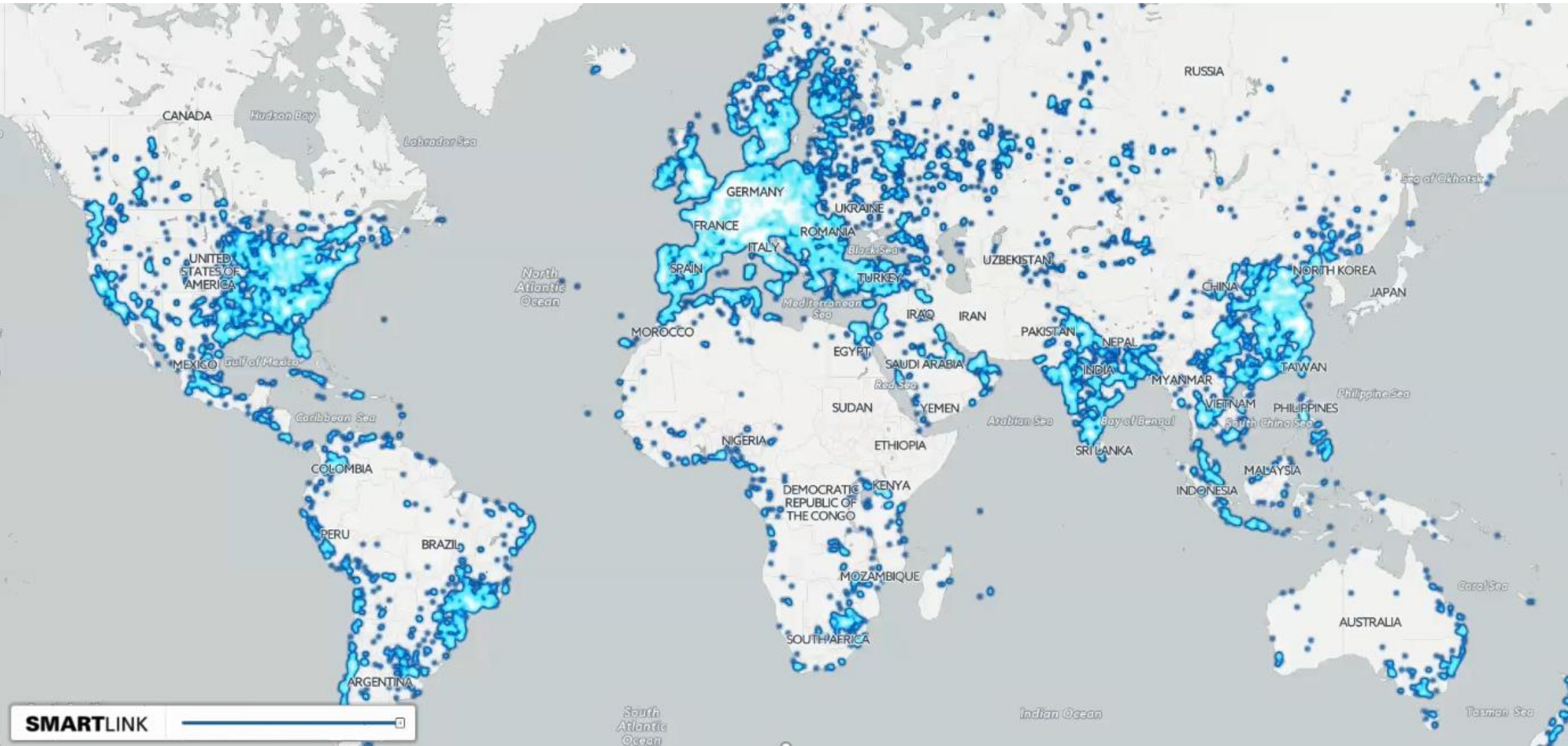

As Maintained: > 120.000 Machines Connected

Condition Monitoring

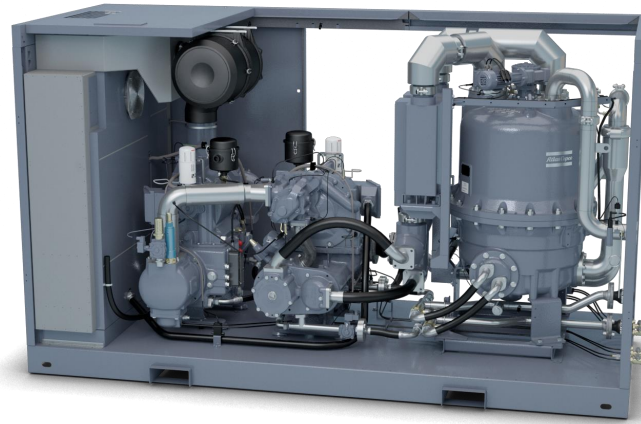

Predictive maintenance

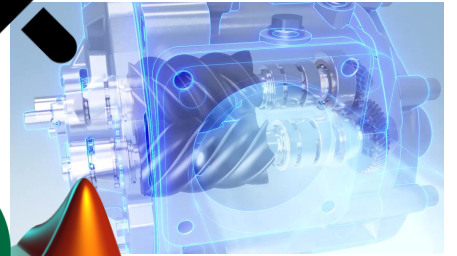

Data analytics to improve Design

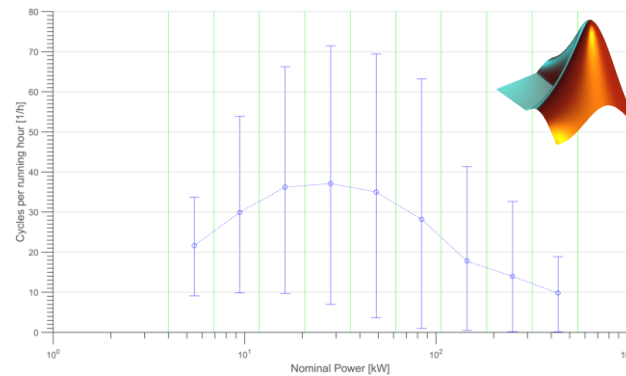

Optimize maintenance

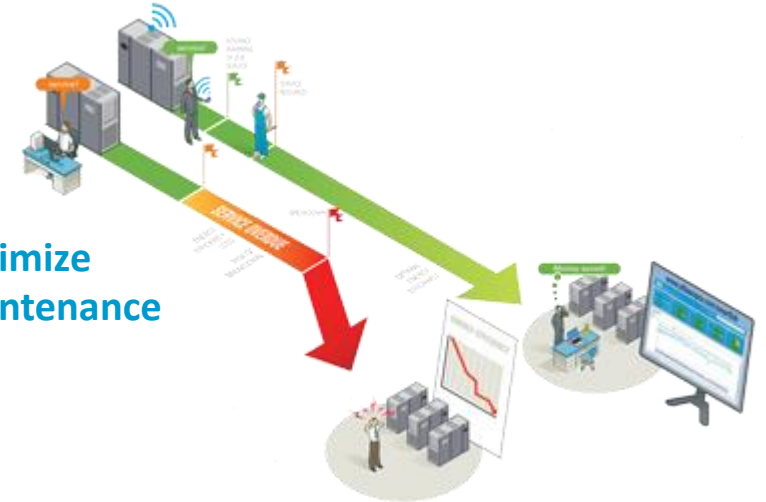

As Achieved: Standardized Atlas Copco Model Based Engineering Platform

- Company-wide workflow preventing design errors and mistakes
- Collaboration platform for efficient communication and quick implementation of upgrades
- High quality continuously updated digital twins used throughout product lifecycle
- Standardized accurate configuration tool used by global sales
- Optimized maintenance and Data Analytics platform for 120k+ connected machines
- Re-establishing Atlas Copco as undisputed global market leader in high quality compressor technology

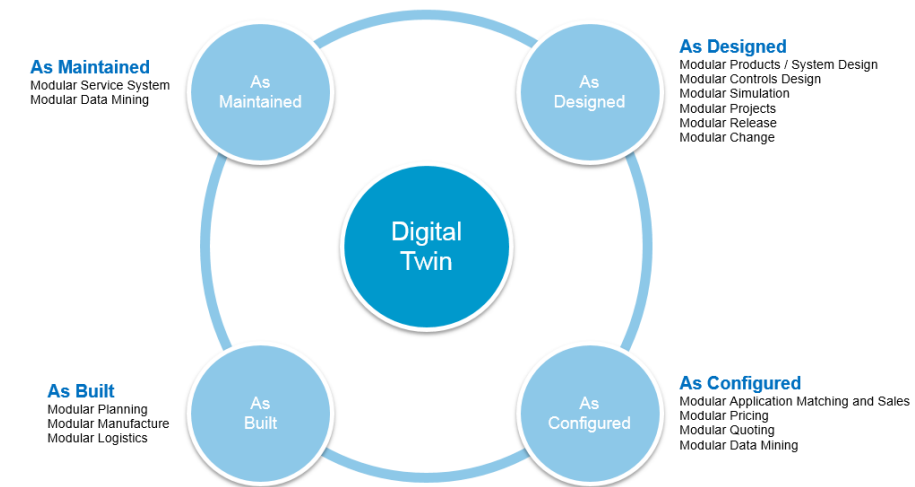

The new ZR160VSD+ shows how value can be created on the path towards the digital twin.

Challenges & Outlook



- Still a long road to take to connect all valuable data
- Labor intensive to clean and structure data
- Databases and Processing engines need to be easily scalable, strong requirement to move to cloud and make software products scalable
- Strong competition in cloud processing and data analytics, fast pace market, MathWorks needs to strengthen their presence
- Integration of Engineering models are key in a successful Digital Twin. It can deliver deep insights for product enhancements and new business models

Questions & Answers

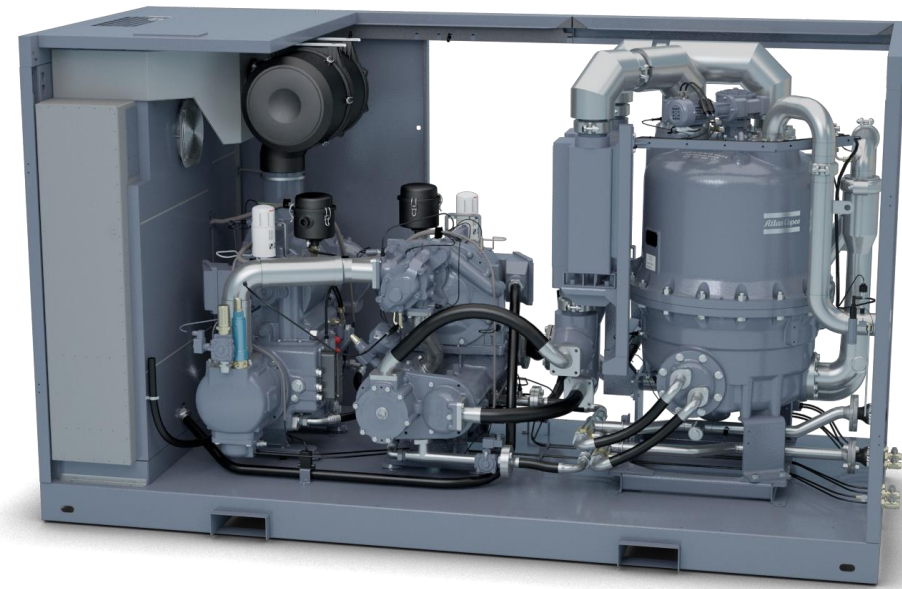

Atlas Copco

