

Using Arduino with MATLAB and Simulink

Dan Seal
MathWorks
Product Marketing

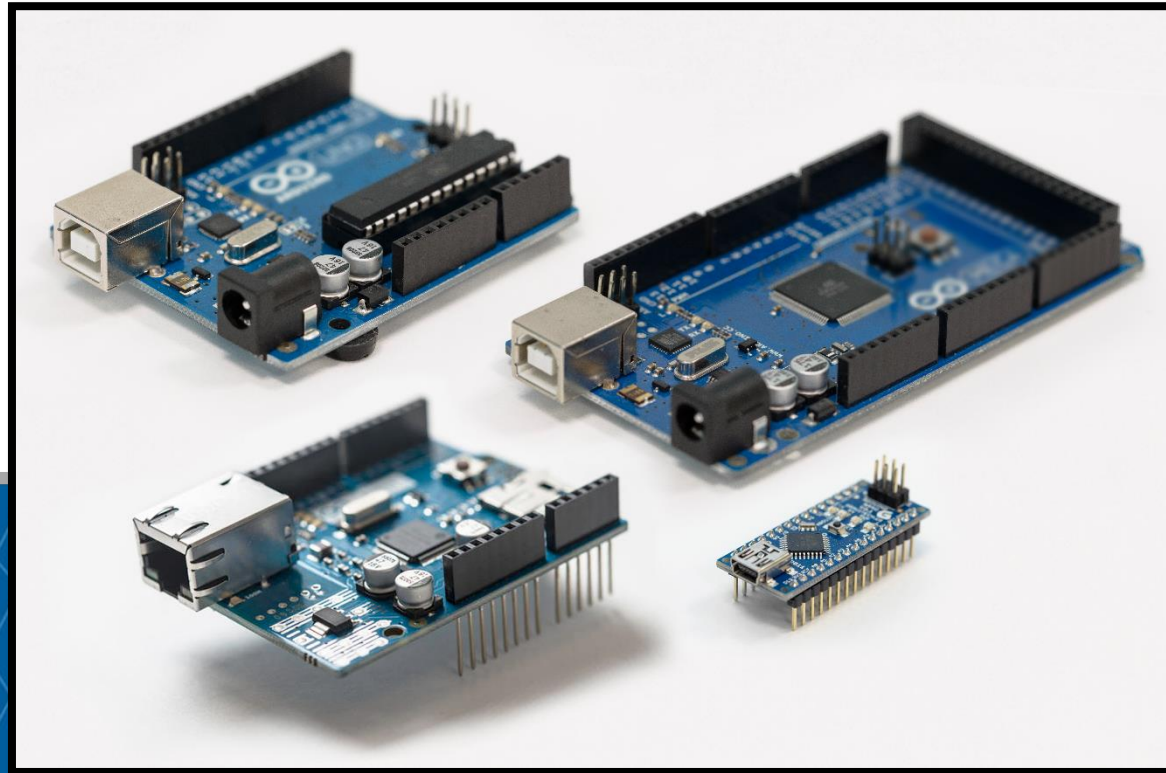

MathWorks Supports Low-Cost Hardware

- Explosion of new hardware platforms available for hobbyists and students
- Increasingly used by educators for project-based learning
- Hardware support packages enable programming these devices with MATLAB and Simulink



What is Arduino?

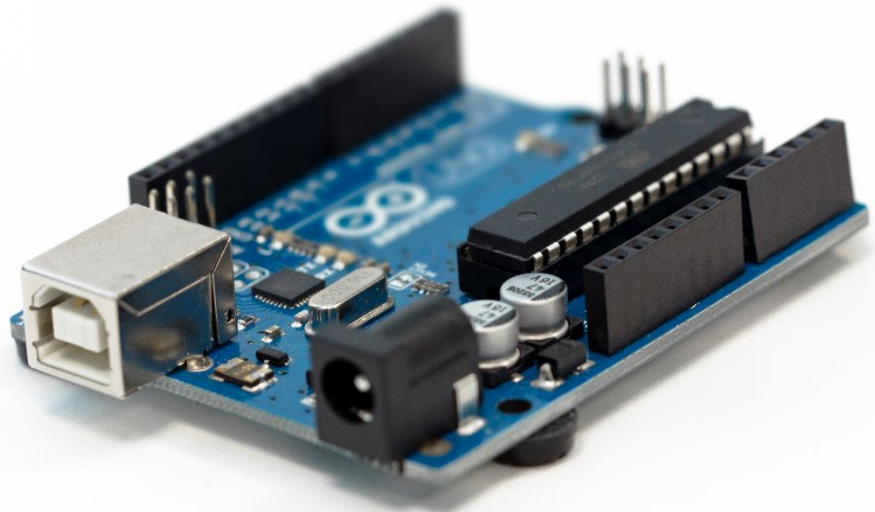

- Low-cost microcontroller board designed for students and makers
- Widely used to teach topics in electronic circuits, controls, and embedded systems
- Projects that can sense and interact with the physical world

Outline

- Getting started
- Demo: Accessing input and output pins in MATLAB
- Demo: Designing and controlling a light meter
- Beyond the basics
- Summary

Sample Application: Rubik's Cube Solving Robot

- Arduino as one part of a larger system controlled by MATLAB
- *What hardware is used?*
 - SparkFun RedBoard (Arduino Uno clone)
 - 2 Servo Motors
 - Webcam
- More details at <http://www.mathworks.com/matlabcentral/fileexchange/49434>

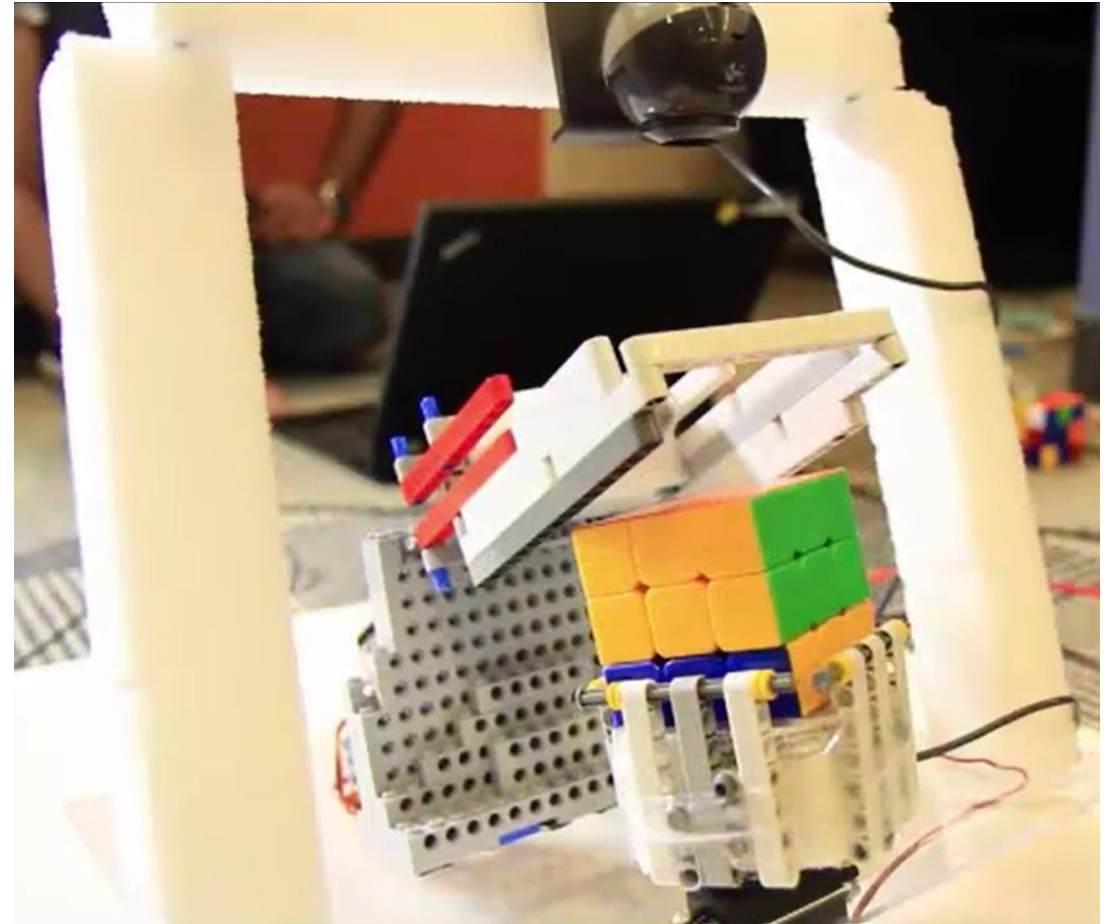

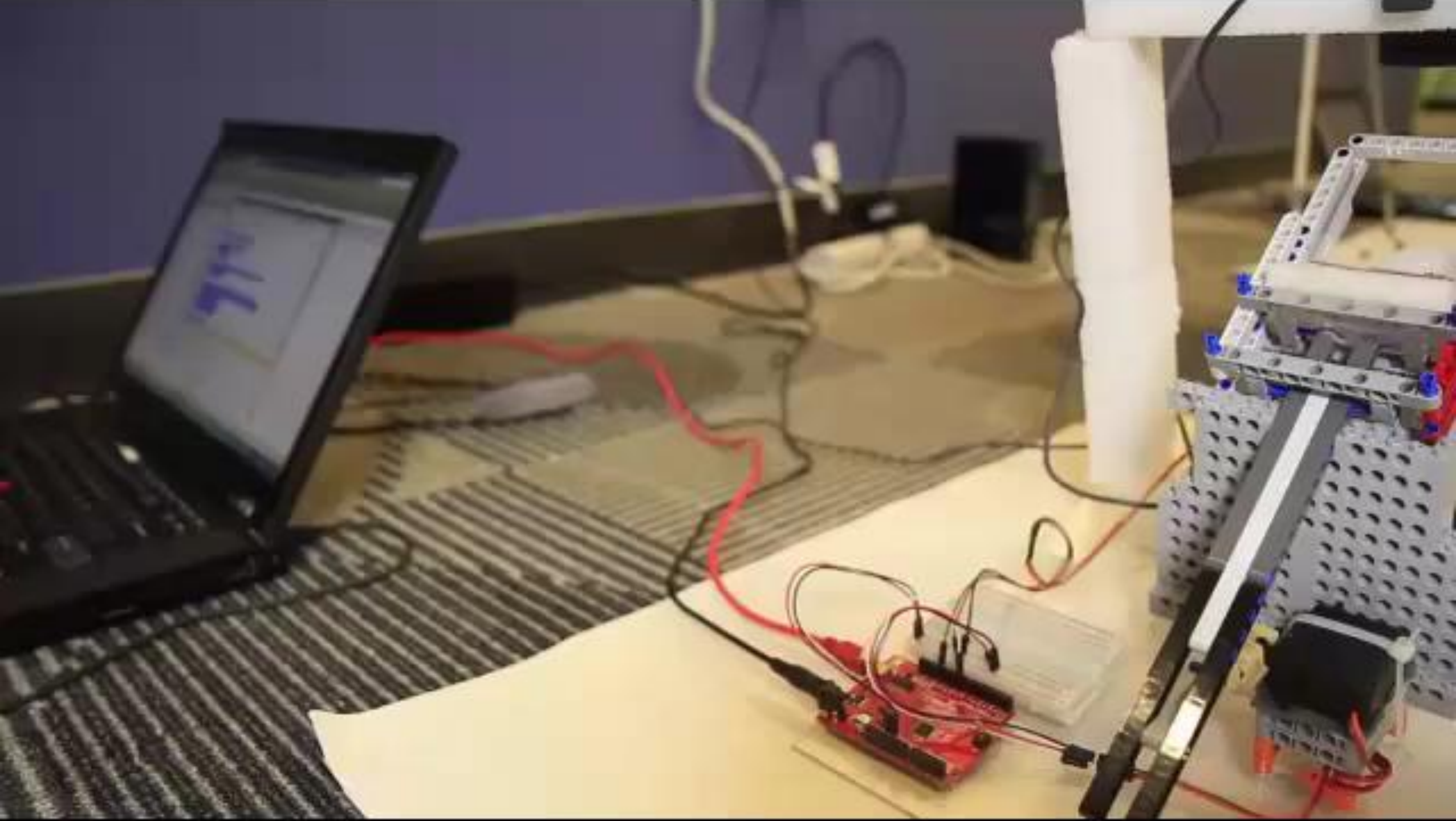

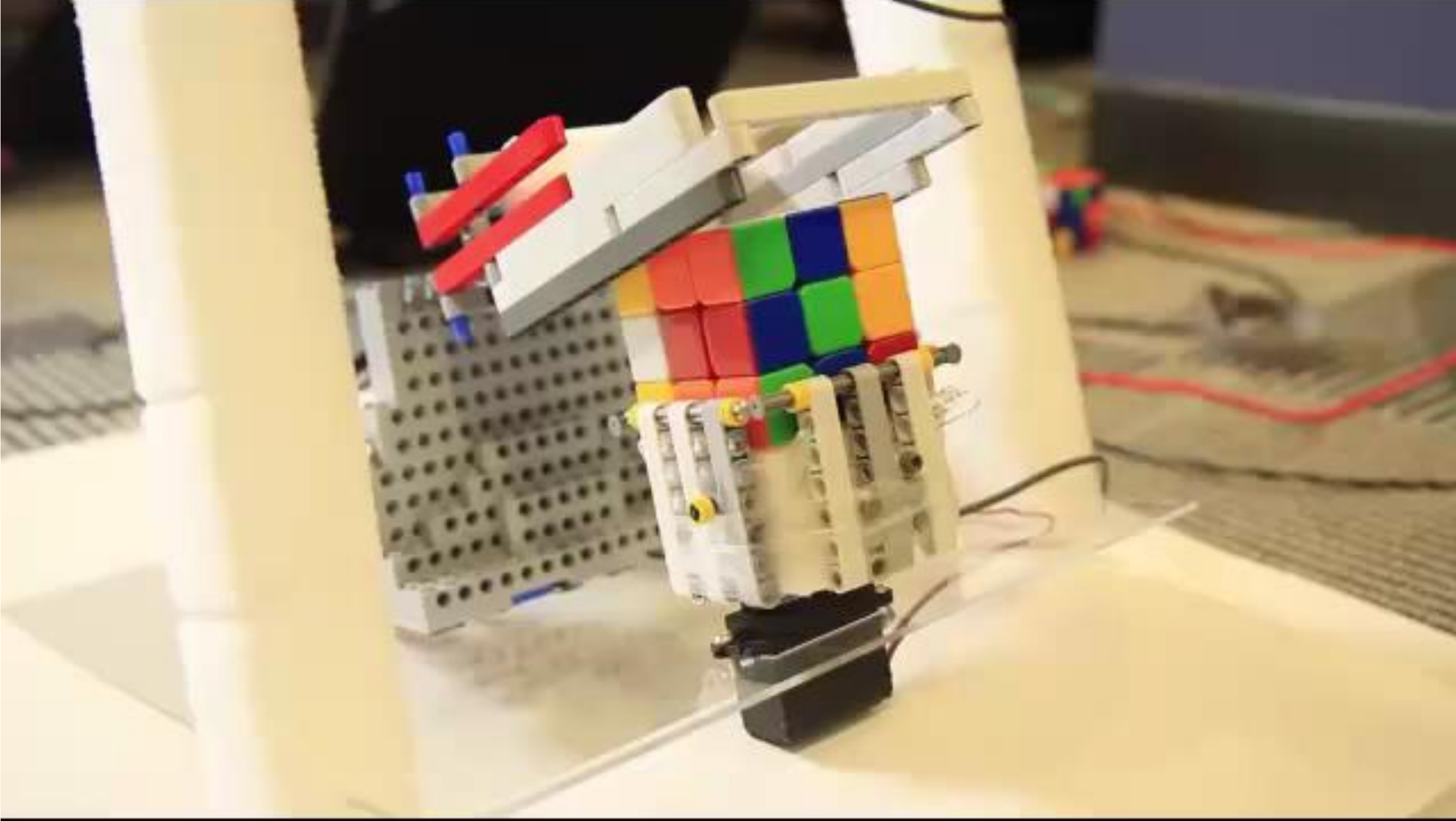

Get Started: Download the Support Packages

- Install through MATLAB with Support Package Installer
- Three Arduino support packages available
 - MATLAB Support Package for Arduino Hardware
 - Simulink Support Package for Arduino Hardware
 - Simulink Support Package for Arduino Due Hardware
- Let's do it together!

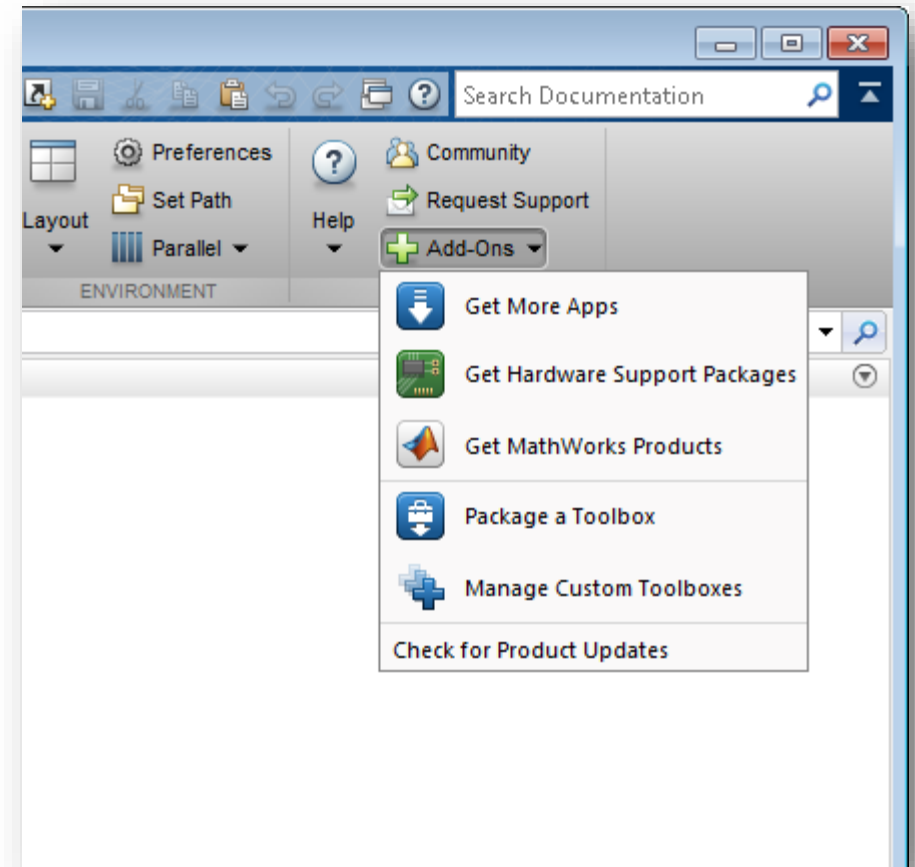

Demo Summary: Simple Inputs and Outputs

- MATLAB Support Package makes it easy to directly control and read the digital and analog pins on Arduino
 - Digital Input
 - Analog Input
 - Digital Output
 - PWM Output
 - Play Tone

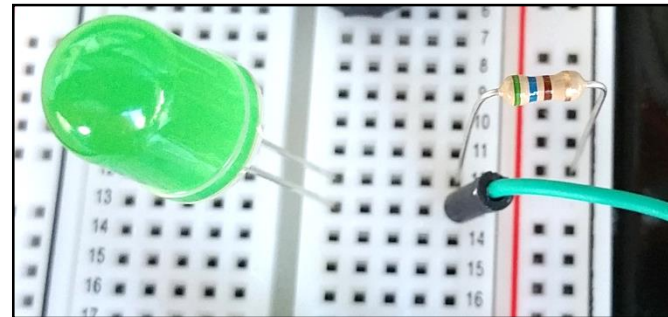
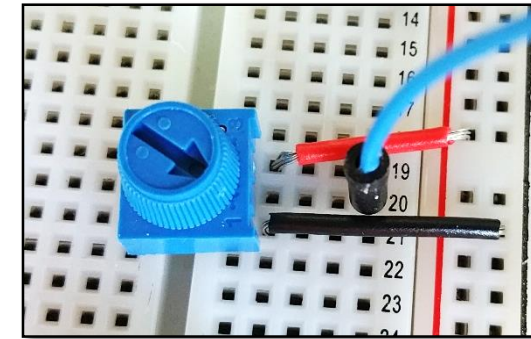
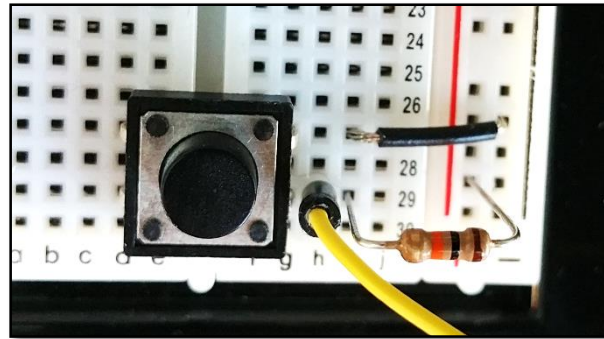

Demo: Light Meter

- Measure light intensity with photoresistor and track extreme values
- Control servo motor to position needle on gauge
- Use Simulink to run the algorithm on the Arduino

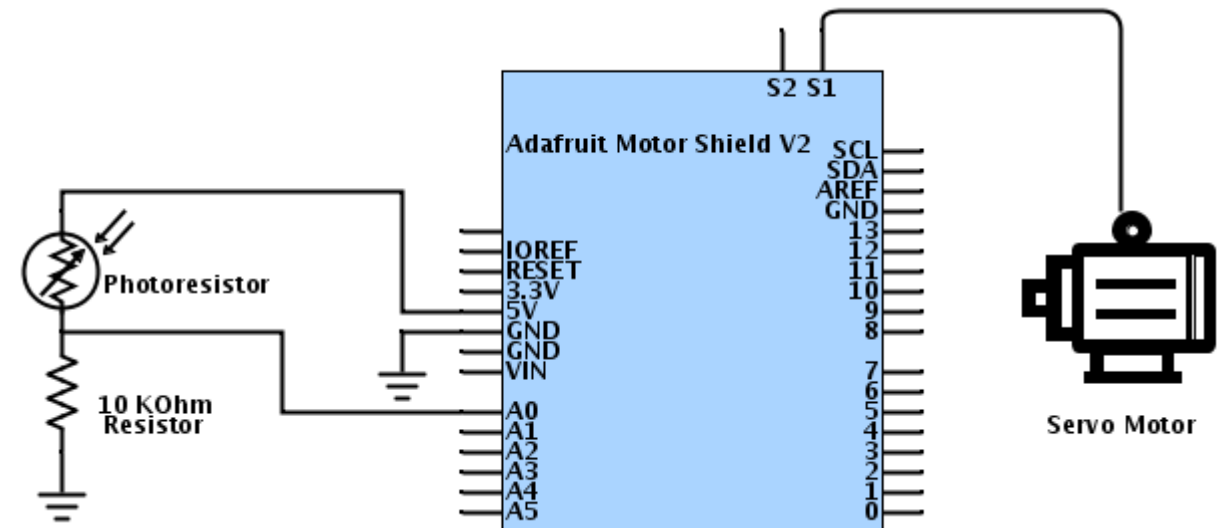
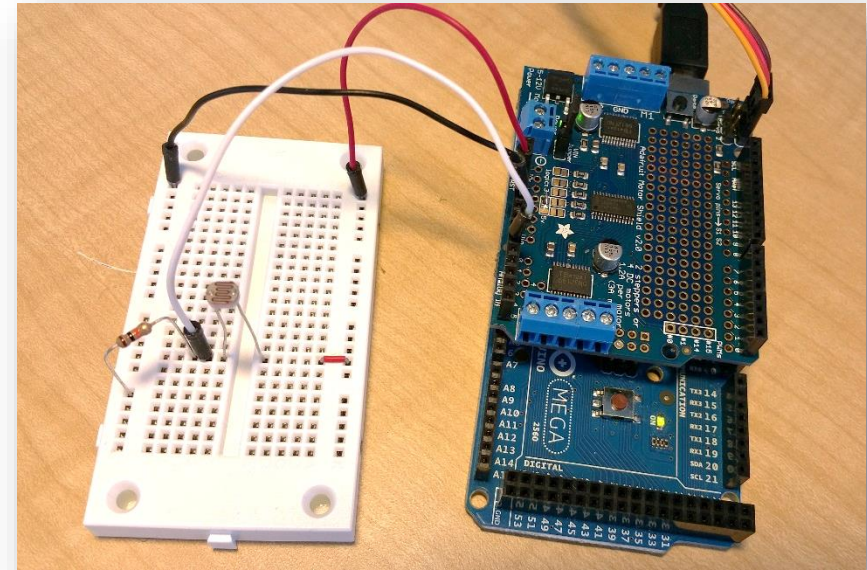

Demo Summary: Light Meter

1. Develop algorithm in MATLAB
2. Build Simulink model containing MATLAB Function block
3. Test and enhance model by running in External mode
4. Deploy to hardware for standalone execution

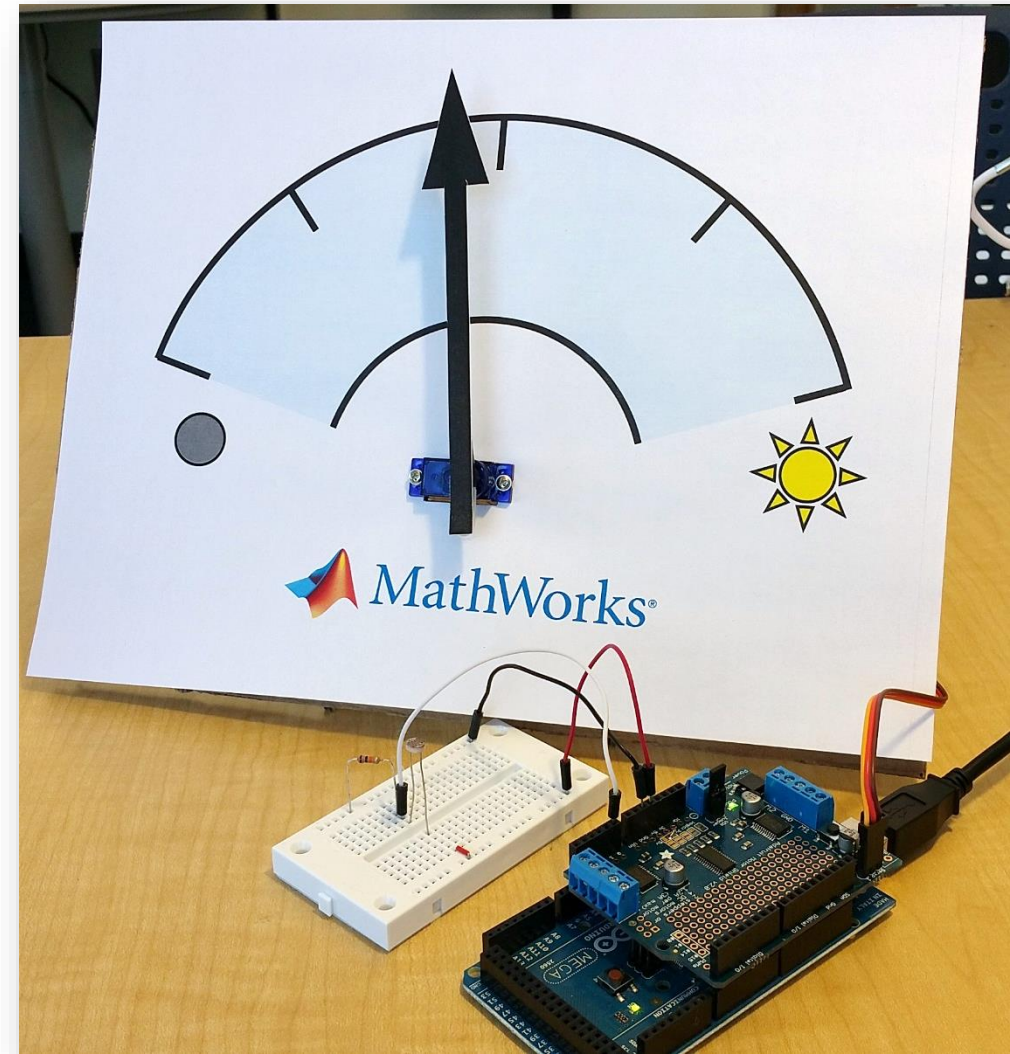

MATLAB vs Simulink Workflows

MATLAB Support Package

- Use hardware as I/O device
- Low-cost data acquisition
- Processing done on desktop
- Must be connected to computer

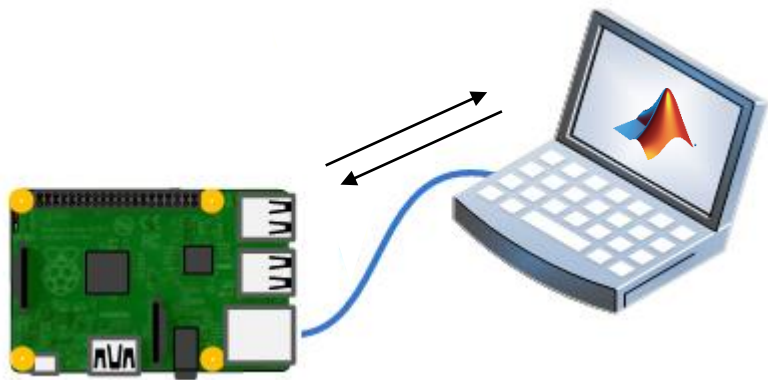

Simulink Support Package

- Develop algorithm in Simulink
- Deploy to hardware
- Processing done on hardware
- Can run independent of computer

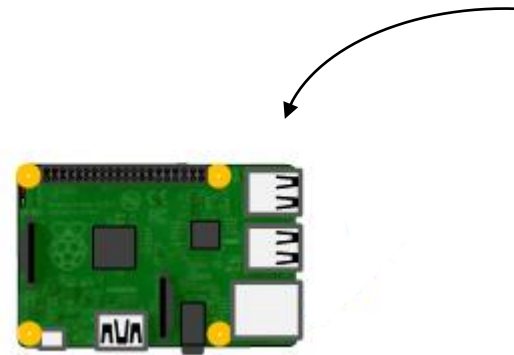

Beyond the Basics: Other Protocols and Capabilities

- MATLAB Support Package has additional functionality for
 - I2C
 - SPI
- Simulink Support Package has additional blocks for
 - Serial receive/transmit
 - Write to ThingSpeak
 - TCP/IP
 - UDP

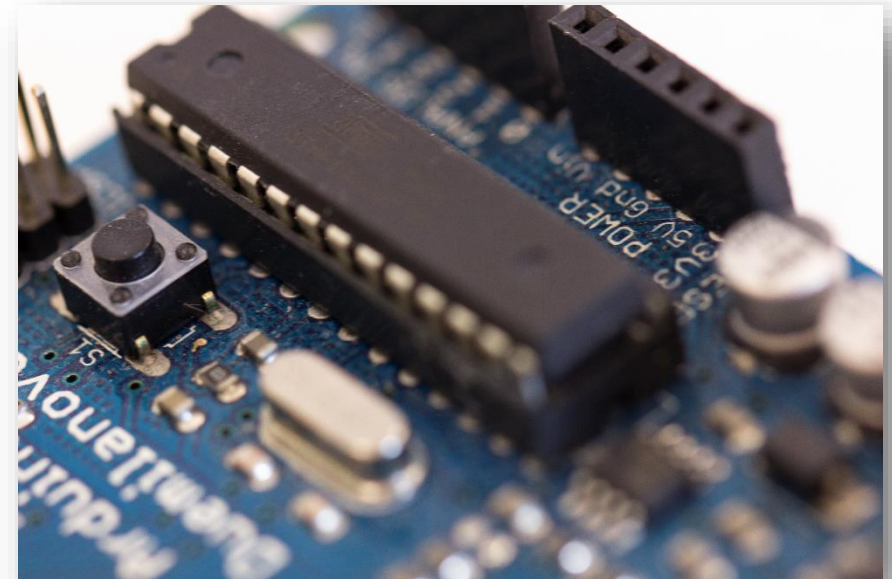

Additional Resources

- More on Simulink Support Packages for Arduino
<http://www.mathworks.com/hardware-support/arduino-simulink.html>
- Discover other projects with Arduino, Raspberry Pi, and LEGO MINDSTORMS at the MakerZone
<http://makerzone.mathworks.com/>
- To explore more hardware support
<http://www.mathworks.com/hardware>
- For higher speed data acquisition
Connect to a wide range of professional DAQ hardware with *Data Acquisition Toolbox*
<http://www.mathworks.com/products/daq/>

Summary

- Get up and running quickly without learning a new programming language
- Bring live results into MATLAB or Simulink
- Deploy to hardware using Simulink
- Talk to other devices over I2C/SPI or send your data over the Internet